

Technical Catalogue

CRIO



Air-Cooled Liquid Chillers for Medium Temperature Applications

Nominal cooling capacity: 7-185 kW | 50 Hz



EK

EUROKLIMAT
Cooling System Solutions

CRIO



SOLID AND LIGHT STRUCTURE

Structure specifically designed and built to guarantee total resistance to atmospheric agents and corrosion. Base and panels made of galvanized steel sheet, oven-painted with polyurethane powders. Equipped with sturdy support feet that facilitate the handling of the unit and allow a simple and quick installation.



EXTRACTOR FAN

The AC extractor fan, installed below the electrical panel, ensures emergency ventilation in case of R290 leakages and allows the dilution of propane.

The AC-type extractor fan allows to convey the air discharge, ensuring an adequate pressure head.



CONVEYED SAFETY VALVE EXPULSION GRID

The safety valve is conveyed outside the unit and a special kit is supplied for the final part of the conveying pipe.

In case of leakages, the dilution of propane is expelled by the extractor fan towards the expulsion grid.



The natural solution for medium temperature applications

ANTI-UV ELECTRICAL CABLE



The electric cables of the fans, which are positioned outside, have a special sheath that protects them from ultraviolet radiation and can withstand even at low temperatures.

EC FANS



High efficiency EC fans, electronically commutated, usefull to reduce energy power consumption.

ELECTRICAL BOARD



Switchboard made according to standards IEC 204-1/EN60204-1, complete with main isolator switch, door interlock safety device.

Protection index: IP54.

The electrical panel is isolated from the rest of the unit and installed in such a way that ensures the separation from the compressor box.

EXTRACTOR FAN



Thanks to the emergency fan, in case of leakages air is pushed into the compressor box, allowing the dilution of propane.

GAS DETECTOR



ATEX certified gas detector installed inside the compressor's box, ensures the activation of the adequate safety measures in case of R290 leakage.

why R290?

CRIO air-cooled chillers offer you optimized natural solutions combining many advantages in a compact package.

RELIABILITY

Propane's refrigerating properties has been well known since the early twentieth century.

Its low density and its thermodynamic characteristics allow a reduction in charge and relatively low working pressures.

Moreover it offers a very **wide range of applications**, so it can be used in refrigeration as well as in conditioning or heating of buildings.

Euroklimat has more than 12 years' experience with R290 chillers and more than 500 units installed throughout Europe for all applications

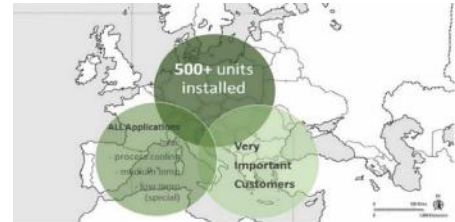

EFFICIENCY

All Models of the CRIO product range are **Eco- Design Ready**.

The EU Ecodesign Directive adopted in 2009 provides rules for improving the environmental performance of products by setting out minimum energy efficiency mandatory requirements for specific product groups.

The CRIO portfolio is additionally divided between "BUSINESS", "HIGH EFFICIENCY" and "HIGH EFFICIENCY +" solutions.

Air-to-Water process chillers		EK EUROKLIMAT	
According to Commission Regulation (EU) 2015/1018 implementing Directive 2009/125/EC "Ecodesign"			
Table 7. Information requirements for medium temperature process chillers			
Model(s)	CRIO 7-1-1 PE		
Type of condensing	Air-cooled		
Indoor air heat exchanger chiller	Yes/No		
Type	Compressor - driven vapour compression		
Driver of compressor	Electric motor		
Refrigerant/Radiant	R290		
Item	Symbol	Value	Unit
Operating temperature	T _a	8	°C
Seasonal Energy Performance Ratio	SEPR	0.038 (1.56)	—
Annual electricity consumption	Q	711049	kWh/a
Parameters at full load and reference ambient temperature at rating point A			
Rated refrigeration capacity	Q _r	118.30	kW
Rated power input	D _r	148.10	kW
Rated energy efficiency ratio	EEPR _A	0.797	—
Parameters at rating point B			
Declared refrigeration capacity	Q _d	281.90	kW
Declared power input	D _d	206.90	kW
Declared energy efficiency ratio	EEPR _B	1.363	—
Parameters at rating point C			
Declared refrigeration capacity	Q _d	271.7	kW
Declared power input	D _d	87.41	kW
Declared energy efficiency ratio	EEPR _C	3.107	—
Parameters at rating point D			
Declared refrigeration capacity	Q _d	250.14	kW
Declared power input	D _d	79.51	kW
Declared energy efficiency ratio	EEPR _D	3.1334	—
Other items			
Capacity control		Fixed	—
Degradation coefficient for chillers	C _d	0.93	—
GWP of the refrigerant	R290	3.3	1450 _{CO₂} (100mass)
Standard rating conditions used	Medium Temperature -LWT +2°C		
Contact details:	EUROKLIMAT Sp.A. - Via Ugolini, 8 - 37010 Solero (PD) Italy		

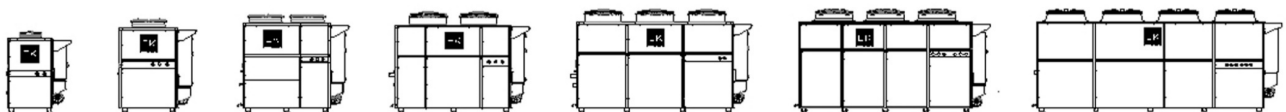

CRIO Advantages

GREEN TECHNOLOGY

Hydrocarbons like propane, and natural refrigerants in general, are particularly suitable for installation in European countries, where the attention to environmental issues and the commitment to reduce CO2 emissions are constantly growing.

R290 is a long-term solution: thanks to its very Low GWP (GWP R290 = 3) it's suitable to be used up to 2030 without any restriction connected to F-Gas Regulation.



HIGH SAFETY

R290 (propane) is a nontoxic flammable refrigerant.

To ensure the **maximum level of safety**, an **Ex-rated Gas detector** is installed as a standard on all units. All CRIO models are designed and manufactured with the aim to ensure the containment of propane. In case of **R290 leakage the emergency fan** is activated, allowing the dilution of propane and conveying the air/propane mixture towards the air outlet, which can be obviously conveyed if necessary. Also the safety valve(s), when fitted, is (are) conveyed outside the unit. Additionally, the separate compartment of the electrical panel ensures very high safety levels.



PLUG&PLAY

CRIO products range provides an all-in-one solution thanks to the integrated **hydraulic module (optional)** which contains all the water circuit components needed for the system to operate correctly. A wide selection of hydraulic couplings is available to fit site configuration:

- Single or twin pump with automatic switchover
- Standard or high pressure pump(s)
- Victaulic couplings

The optimized foot-print reduce the use of the surface area for easy integration into an existing building. **Quick, easy and cost-effective installation and commissioning.**



CRIO Technical features

CRIO BS: BUSINESS RANGE



Eco Design Ready



EC Fans



Inverter available

CRIO BS - Cooling capacity (kW)

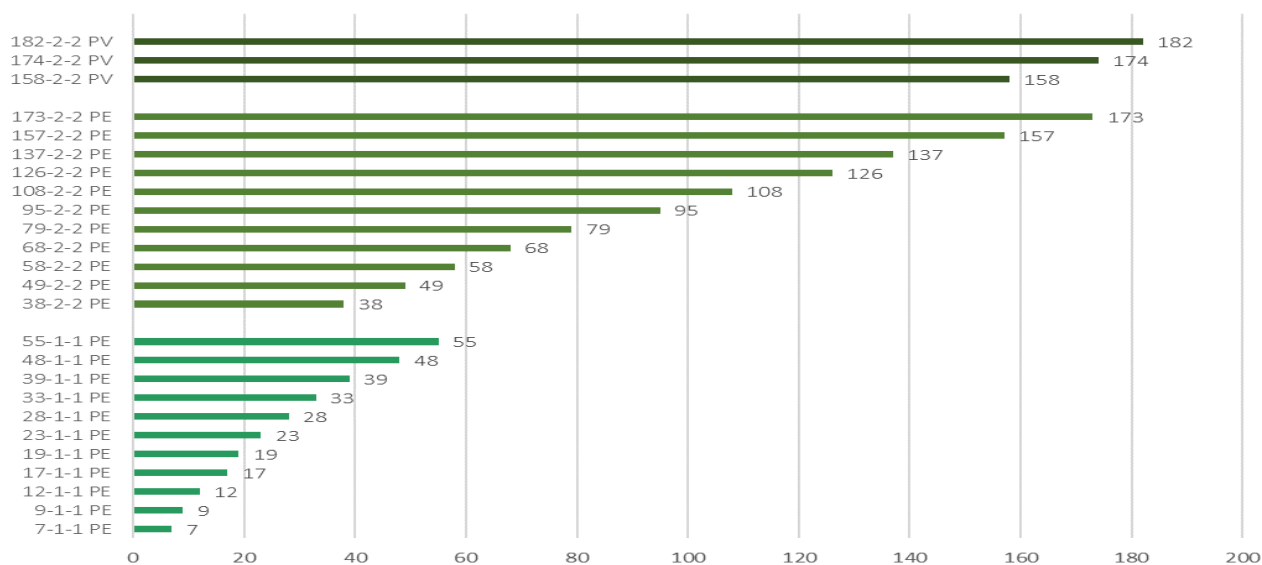

CRIO BS: BUSINESS RANGE

Cooling capacity from 7 kW to 182 kW

	N. of refrigerant circuit	Compressor Quantity	Fans quantity	Evaporator type	Condenser type
7-1-1 PE ↔ 28-1-1 PE		1	1	1	
33-1-1 PE ↔ 55-1-1 PE		1	2	2	
38-2-2 PE ↔ 68-2-2 PE		2	2	2	
79-2-2 PE ↔ 137-2-2 PE		2	3	3	
157-2-2 PE ↔ 173-2-2 PE		2	4	4	
158-2-2 PV ↔ 182-2-2 PV		2	4	4	

ICONS LEGEND



Refrigerant R290 | GWP=3



Semi-hermetic piston compressor



Axial fan



Brazed plate heat exchanger



Single circuit



Double circuit



Cu/Al condensing coils



Microchannel condensing coils

CRIO Technical features

CRIO HE/HE+: HIGH EFFICIENCY RANGE



CRIO HE - Cooling capacity (kW)

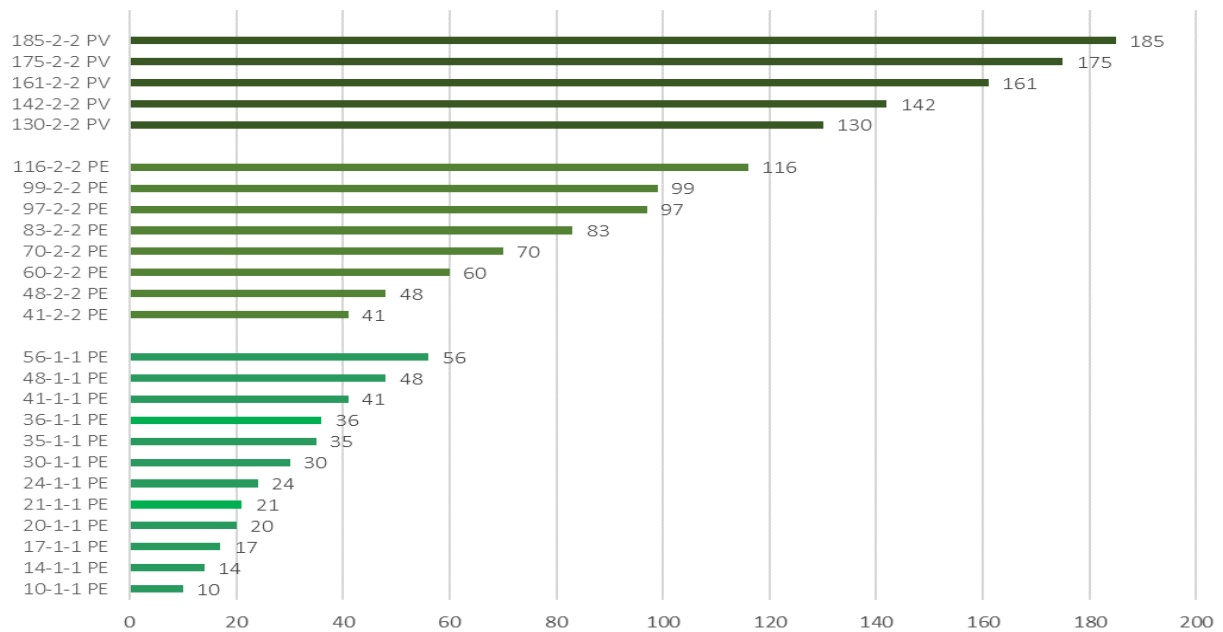

Cooling capacity from 10 kW to 185 kW

	N. of refrigerant circuit	Compressor Quantity	Fans quantity	Evaporator type	Condenser type
10-1-1 PE ↔ 17-1-1 PE		1	1	1	
20-1-1 PE ↔ 48-1-1 PE		1	2	2	
56-1-1 PE		1	3	3	
41-2-2 PE ↔ 97-2-2 PE		2	3	3	
99-2-2 PE ↔ 116-2-2 PE		2	4	4	
130-2-2 PV ↔ 142-2-2 PV		2	4	4	
161-2-2 PV ↔ 185-2-2 PV		2	6	4	

ICONS LEGEND



Natural refrigerant Propane & flammability

Interest and application of hydrocarbon (HC) refrigerants is growing, especially now that the global warming impact of refrigerants is becoming an increasingly important aspect for the refrigeration and air conditioning industry.

It is widely known that HCs are excellent refrigerants in terms of performance and because of their negligible environmental impact aspects. However, it is generally acknowledged that their main hindrance is related to their flammability.

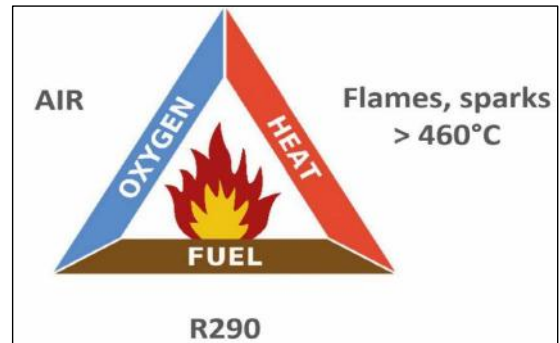

If you control these components, fire can be avoided

To achieve this, Euroklimat has considered three general guidelines:



Containment of the substance (propane – R290)

- CRIO units have leak-tight refrigerant circuits, sufficiently robust throughout the unit's lifetime.
- Pipework is designed to have as few pipe joints as possible.
- All the materials are fully compatible with the HC refrigerant.



Avoidance of ignition sources

- All electrically powered components are switched off in case of leakage, exception made for the gas detector and the emergency fan.
- Electrical panel is fitted in a separate compartment.
- Cable glands are at least IP65 and units have a double-barrier.



Use of leak detector & ventilation system

- Every unit is equipped with a stand-alone gas detection system.
- The sensor is ATEX Certified and is pre-calibrated at the factory. The sensor must be calibrated at least once a year.
- The fan is automatically activated in case of unlikely leak of propane.

Protection of workers that may come into contact with flammable atmospheres in the workplace.

This may be achieved through leak-tight design, ventilation and appropriate protective systems (for example portable leak detectors).

Where a flammable atmosphere can arise, people responsible for the positioning and/or installation of the equipment must ensure that a detailed risk assessment of the installation area has been done.

Safety



Euroklimat Approach

- In-depth knowledge of the basic principles for the safe use of flammable HC refrigerants.
- Study of the safe design of refrigeration circuits using flammable refrigerants.
- More than 12 years-experience on R290 applications in several countries.

Constant improvement of the risk analysis to:

- Ensure that a detailed safety evaluation has been carried out.
- Enable the identification of ways and means to improve the level of safety of the systems and equipment, by way of detailed investigations of all of the factors that affect the risk.

ISO 9001 Quality certification in order to:

- Ensure the customer a certification path
- Run the validation process of the project pre-market

Containment of R290

With the aim of further improving the safety level of the units and ensuring a simpler evaluation of the installation, Euroklimat developed the new CRIO range with a basic safety principle based on the containment of the flammable substance.

Containment of the substance is obtained by:

- Closed box in which all the refrigerant-containing components (with the obvious exception of the condensing coils) are fitted
- Gas detector – ATEX certified detection system
- Extraction fan – EC type
- Conveyed safety valve(s), made in such a way that in case of valve(s) opening, the extractor fan is activated.

In case of leakage, the above-mentioned components allow the ventilation of the closed box and the dilution of propane below the Lower Flammable Limit.

This system ensures an **easier risk assessment of the unit's installation area.**



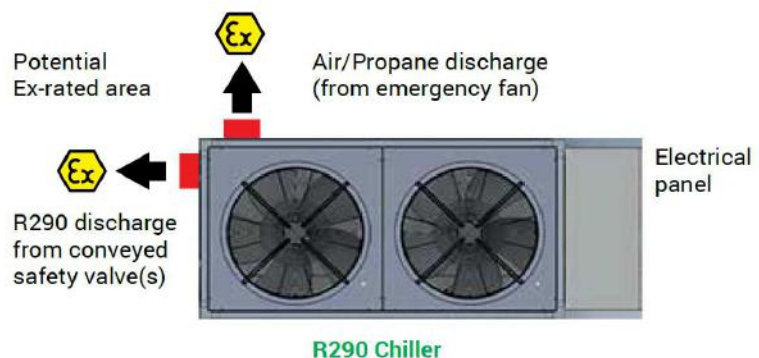



Potential Ex-rated area may be generated at the discharge of safety valve(s) and at the discharge of the emergency fan (see picture below): if necessary, the installer can easily convey these two elements towards a safe area.



Maximum allowable R290 charge

Maximum allowable charge of Refrigerating systems and heat pumps should be evaluated according to EN378:2016. EN378:2016 is a safety and environmental standard published by CEN that provides guidance for Design, Construction, Installation, Operation and Maintenance of Refrigerating systems and heat pumps.

Maximum allowable charge depends on:	CRIO Air-cooled chillers	
	Gas Classification	A3 (High Flammability, Low Toxicity)
	Application Type	All applications in particular Human Comfort
	Equipment location	Machinery room or open air
	Installation Characteristics 1	Other
	Installation Characteristics 2	Above ground
	Installation type	Floor location
	Device Type	Fixed system
Access Category	General, Supervised, Authorized	

Access Category		Max. allowable R290 charge		CRIO BS	CRIO HE/HE+
	General		5 kg	7-1-1 PE ↔ 33-1-1 PE 38-2-2 PE ↔ 79-2-2 PE	10-1-1 PE 24-1-1 PE 41-2-2 PE
	Supervised		10 kg	7-1-1 PE ↔ 55-1-1 PE 38-2-2 PE ↔ 137-2-2 PE 158-2-2 PV ↔ 182-2-2 PV	10-1-1 PE ↔ 48-1-1 PE 41-2-2 PE ↔ 97-2-2 PE 130-2-2 PV ↔ 142-2-2 PV
	Authorized		NO LIMITS	All models	All models

CRIO

R290 Gas detector & Calibration kit

Gas Detector - Main features

PX2 - PolyXeta®2 gas warning device for R290 Propane gas is designed to detect combustible gases in the hazardous areas of zones 2 according to Directive 2014/34/ EU.

- » **ATEX** certified
- » Standard Alarm setting: **10% of LFL**
- » **4 – 20 mA** output signal
- » **RS485-Modbus** output signal
- » Alarm and fault signal relays
- » **Separate power supply 230V-1ph-50Hz**



The complete manual of the component is always attached at the end of EK installation manual.

Calibration kit

At least once a year the component must be checked and calibrated properly to comply with the requirements of European Regulations and Standards.

Euroklimat can provide the equipment necessary for calibration. The Calibration kit, available as accessory for all models is made of the following components:

» **Gas application kit:**

it must be put on the sensor head to convey test gas/zero gas.
It allows a better and more precise measurement of the substance.



» **Service Tool:**

it is necessary for gas detector version without display (our standard) and allows an easy and simple access to zero and gain calibration.

- » Kit for withdrawal of gas consisting of **flow meter and pressure regulator indicators**



NOTE: Only a qualified technician must perform the calibration procedure.

Zero gas - Synthetic air (20 % O₂, 80 % N, < 10 % RH) and Test gas bottles are not included in the Calibration kit accessory given by Euroklimat.

CRIO configurations

The below legend allows you to easily select the proper configuration of CRIO chiller.

CRIO BS A BP / ST / AS / EC / 1S 038-2-2 PE

Range

CRIO BS - Business
CRIO HE - High Efficiency
CRIO HE+ - High Efficiency+

Unit Type

A - Chiller Air/Water

Solution

BP - Base (brazed plate evaporator)
PP - Base with pump (brazed plate evaporator)
TP - Base with tank (brazed plate evaporator)
IP - Integrata (tank + pump / brazed plate evaporator)

Version

ST - Standard
LN - Low Noise
SL - Super Low Noise

Equipment

AS - Standard solution
DS - Desuperheater
HR - Total modulating Heat Recovery

Fans control

EC - EC Fan

Compressor

1S - 1 partial step compressor(s)
2S - 2 partial step compressor(s)
3S - 3 partial step compressor(s)
4S - 4 partial step compressor(s)
II - VFD compressor(s)

Size

Base-P MP 1-0 OO

Hydronic kit

Base-T - Base solution with tank
Base-P - Base solution with pump
Integrata - INTEGRATA solution with pump and tank

Pressure Head

LP - Low Pressure head (150 kPa)
MP - Medium Pressure head (300 kPa)
HP - High Pressure head (500 kPa)

Number of operating - stand-by pumps

Pump(s) control

OO - ON-OFF control
II - VFD control

CRIO operating limits

CRIO/BS: OPERATING LIMITS - COOLING

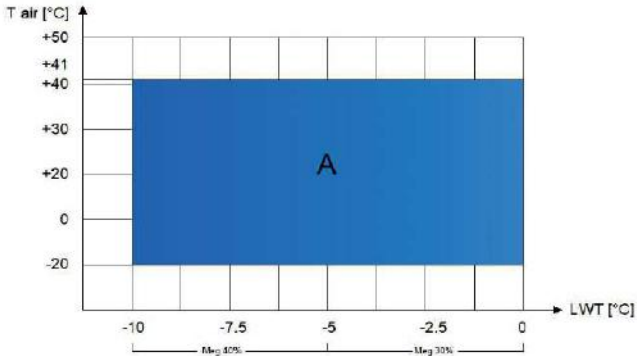

Standard operating area
[dT condenser water side: min. 3 max. 7K]

T air: Outdoor air temperature [°C] (DB)
LWT: Evaporator outlet temperature [°C]

CRIO/HE & HE+: OPERATING LIMITS - COOLING

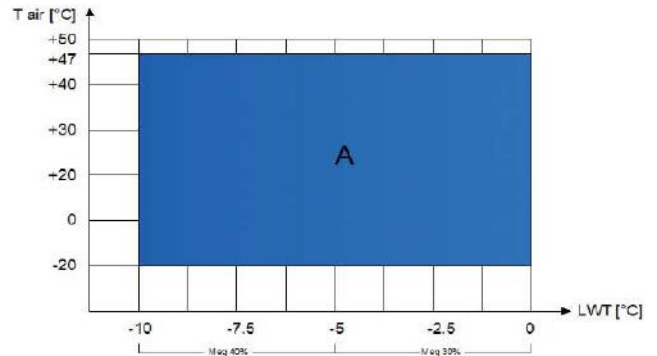

Standard operating area
[dT condenser water side: min. 3 max. 7K]

T air: Outdoor air temperature [°C] (DB)
LWT: Evaporator outlet temperature [°C]

CRIO/BS: TOTAL HEAT RECOVERY OPERATING LIMITS

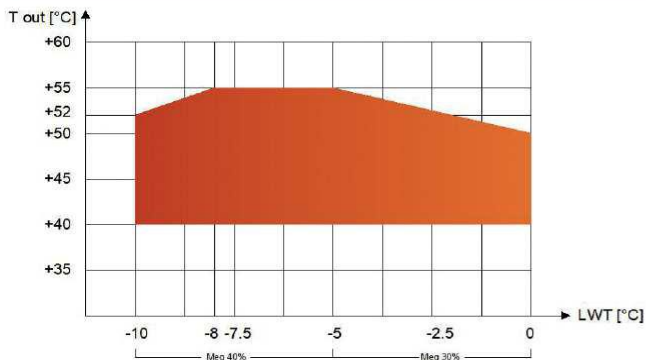

Standard operating area
[dT evaporator water side: min. 3 max. 7K]

T out: Heat Recovery heat exchanger outlet water temperature [°C] (DB)
T air: Outdoor air temperature [°C] (DB)

CRIO/HE & HE+: TOTAL HEAT RECOVERY OPERATING LIMITS

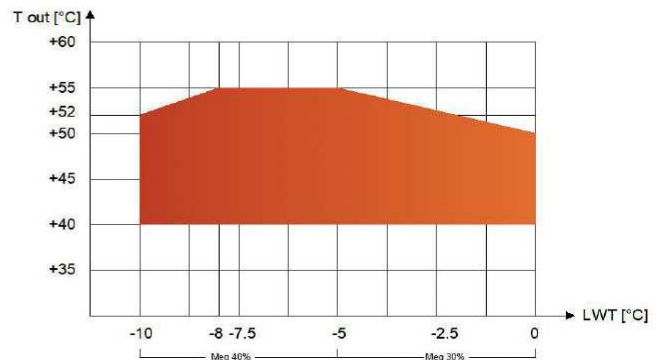

Standard operating area
[dT evaporator water side: min. 3 max. 7K]

T out: Heat Recovery heat exchanger outlet water temperature [°C] (DB)
T air: Outdoor air temperature [°C] (DB)

CRIO/BS: DESUPERHEATER OPERATING LIMITS

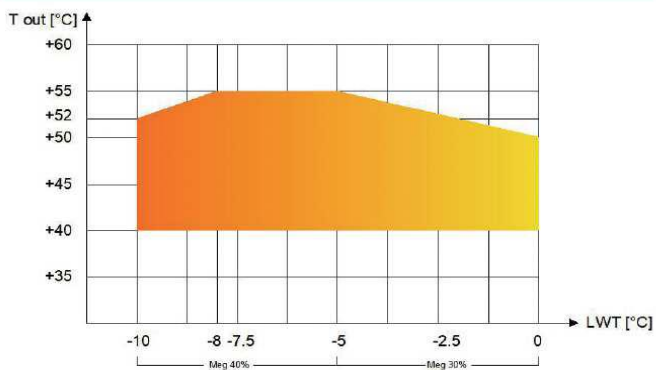

Operating area with Desuperheater

T out: Desuperheater heat exchanger outlet water temperature [°C]
T air: Outdoor air temperature [°C] (DB)

CRIO/HE & HE+: DESUPERHEATER OPERATING LIMITS

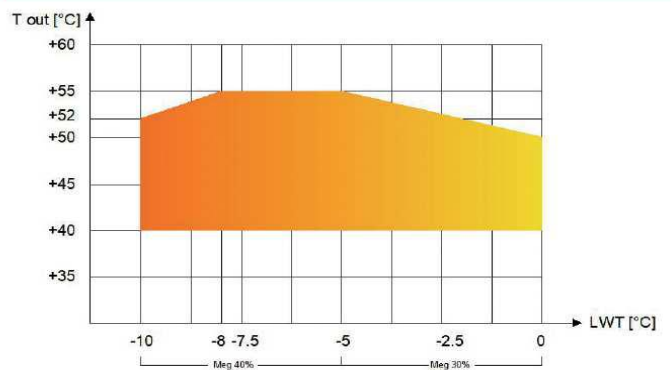

Operating area with Desuperheater

T out: Desuperheater heat exchanger outlet water temperature [°C]
T air: Outdoor air temperature [°C] (DB)

Connected controller

Thanks to a Multitasking Operating System and to the adoption of standard protocols, local and remote connectivity the controller used in eks chillers is the most advanced technology available.



NEW OPERATING SYSTEM

New Multitasking Operating System ensures optimal system resource usage, extended data types for user application (32bit floating point numbers) application speed increase and independent protocol engines.



CONNECTIVITY

The controller has two integrated Ethernet interfaces, three serial interfaces and two USB ports.

A great choice of communication protocols is possible (Modbus, Carel, BACNet, LON, Konnex, TCP/IP, HTTP, FTP, DHCP, DNS, NTP, SNMP and many others).



CLOUD SERVICE

Plug & Play solution for tERA platform connection. All tERA services are available just connecting the Ethernet plug to your home or office network, without the need for an external connection box.

R290 reciprocating compressor with inverter

Advantages

When comparing with alternative control systems and technologies, a frequency converter is the optimum energy control system for controlling compressors.

- » Improved system quality
- » Maintaining a constant leaving water temperature
- » Wider range of operation of the heating or cooling power
- » Increased power by increasing the speed compressor
- » Energy saving
- » Longer compressor lifetime
- » Better possibilities of providing monitoring and diagnostics



Energy consumption minimized and maximizing comfort levels thanks to CRIO's INVERTER

Exact capacity match

Thanks to the advanced P.I.D. control, a last-generation inverter frequency control system and electronic expansion valve management algorithm, the CRIO is able to maintain the constant outlet temperature (LWT) very close to the required Set-point, even when the load variations required by the system (demand) are very high.

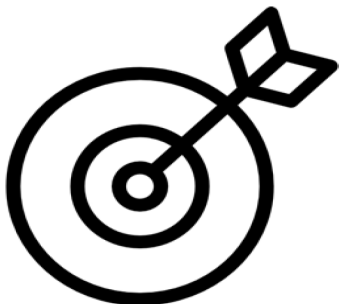

Star/Delta Starter or Soft-starter not Required

When larger motors are started, it is necessary in many countries to use equipment that limits the start-up current.

In more traditional systems, a star/delta starter or softstarter is widely used. Such motor starters are not required if a frequency converter is used.

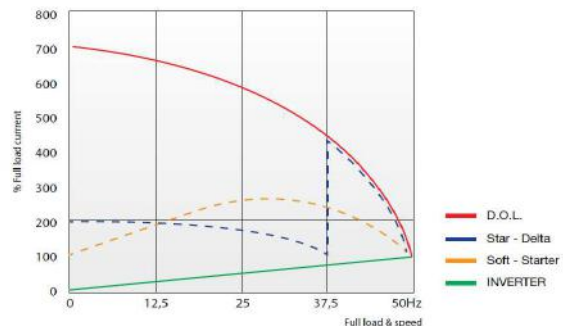

CRIO

Acoustic configurations

ST - Standard



This solution is suitable for installations where no particular silence is required.



Painted galvanized sheet panels

LN - Low Noise



It represents a good compromise between price and performance in terms of reducing noise levels.



Painted galvanized sheet panels, insulated with polyurethane foam sheets, polyester based, anthracite colour, self-extinguishing non dripping.

SL - Super Low Noise



This configuration is ideal for all applications where the noise of the machine is an essential aspect.



Sandwich soundproofing galvanized sheet panels, painted outside and isolated with high-density rock wool (100 Kg/m³)

CRIO

Sounds levels

Sound levels are obtained by means of theoretical calculations that could deviate from the real conditions of the place of installation of the unit.

Sound Power: this is the acoustic emission of the unit when operating. It is dependent on operating conditions. Sound power level in compliance with ISO 3744.

Sound Pressure: this is the measurement of the effect of the acoustic emission generated by the unit at a certain distance and in the acoustic environment (reflection, absorption, directivity) in which it operates. The value will depend on the sound power of the unit, the directivity of the source and the reflectivity of the surroundings. Sound pressure level (average value), calculated for unit in a free field on a reflective surface; non-binding value obtained from the sound power level.

It is assumed that sound power and sound pressure are linked together by defining the space and conditions as follows:

- the source is omnidirectional, i.e. the acoustic emission is the same in all directions
- the conditions are free field, i.e. at 1 meter from the source there is no effect from acoustic wave reflections with the exception of the support plane

The power is therefore distributed over an imaginary sphere around the unit and the following relationship applies:

- sound pressure at 1 m = sound power - 11 dB (A)



Heat recovery

What is waste heat?

All air-conditioning and refrigerating systems transfer heat from one location to another through the use of electrical work. At the evaporator heat exchanger, heat is drawn into the system to provide indoor cooling while heat leaves the system in the form of wasted heat at the condenser (see figure on the side). The amount of wasted heat is higher than the cooling that the process creates.

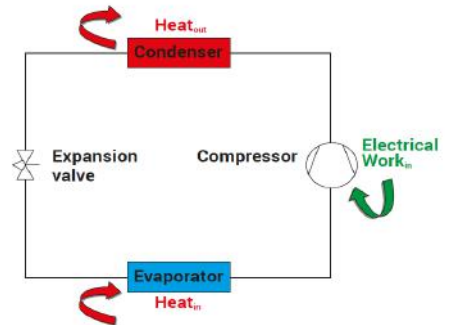

Is it possible to save energy by recovering waste heat from chillers?

The answer is **YES**: this heat, which is otherwise wasted to the environment, can be used for different purposes, such as building/room heating, sanitary hot water and process heat applications.

Benefits of Heat Recovery

The use of a recovery system to generate hot water can reduce the total energy needs of a building and/or a process and allows a significant increase of the global efficiency of the system.

The benefits of Heat recovery systems are several:

Increased efficiency, due to the possibility to use both chilled and hot water for different purposes. To better understand this point, we can analyze the EER (Energy Efficiency Ratio) of the unit without heat recovery system and the TER (Total Efficiency Ratio) with heat recovery system. According to its definition, the EER is the ratio between Q_c (cooling capacity) and the absorbed electrical power W_{el} . For a unit with heat recovery system, the TER is the ratio between the sum of useful effects Q_c and Q_{rec} (cooling capacity and recovered heat) and the absorbed power.

$$EER = \frac{Q_c}{W_{el}} \quad TER = \frac{Q_c}{W_{el}} + \frac{Q_{rec}}{W_{el}} = \frac{Q_c + Q_{rec}}{W_{el}}$$

Reduction of Energy costs: if there are simultaneous heating and cooling loads, it's possible to recover heat from chillers instead of rejecting it to the environment. This gives a double benefit: recovered heat reduces the costs of purchased heat and also reduces the ancillary power necessary to reject the heat (for example cooling towers and/or dry coolers).

A qualitative representation of the cost benefits compared to standard heat generation methods is shown below:

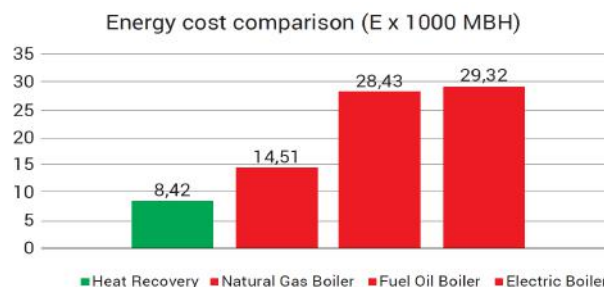

Reduced Environmental Emissions: energy recovery not only reduce operating costs, but also reduce emissions to the environment. Heat recovery systems allows the reduction of heat generated by burning fossil fuels (such as natural gas), and consequently the reduction of site emissions.

Energy codes and Government incentives: considering the benefits of the above-mentioned points, in different countries there are standards and building codes that require condenser-water heat recovery for service water heating and/or economical incentives for the installation of recovery systems.

Different types of heat recovery

Options available

DS (DESUPERHEATER)

An additional BPHE (brazed plate heat exchanger) heat exchanger is installed between scroll compressor and air-cooled condenser.

- Main features:**
- Captures heat from superheated refrigerant, exploiting the hot discharge gas.
 - It is possible to recover only a small amount of heat (up to about 20% of the condensation heat) as this exchanger only deals with the sensible and not latent exchange. The latter takes place in the air-cooled condenser.
 - Hot water temperatures up to 55°C can be achieved.

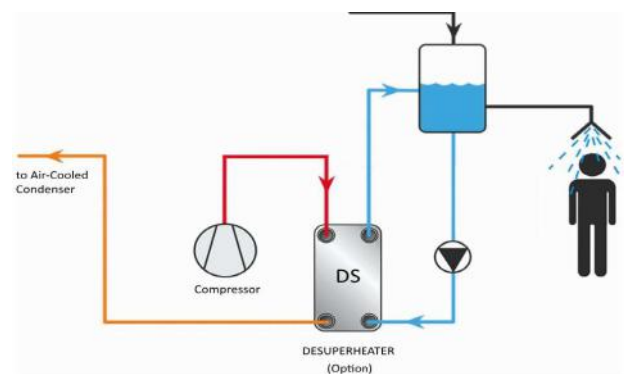
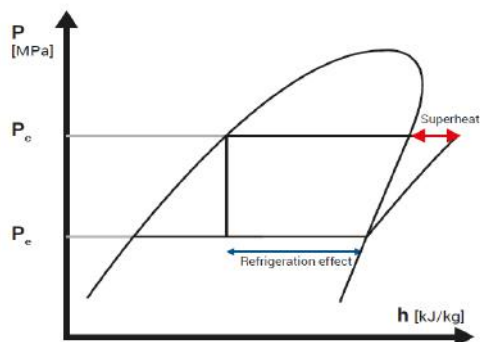

HR (TOTAL MODULATING HEAT RECOVERY)

An additional BPHE (brazed plate heat exchanger) is installed in parallel to air-cooled condenser and the design of the refrigerant circuit allows to recover the total available condenser heat.

- Main features:**
- Captures heat from refrigerant condensing process.
 - Compared to the DS, it is possible to recover a much greater quantity of heat because the latent heat exchange is exploited.
 - Hot water temperatures up to 55°C can be achieved.

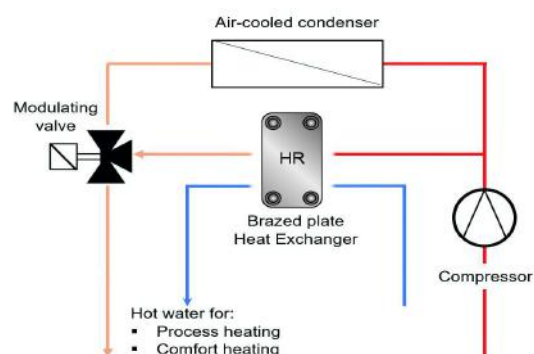
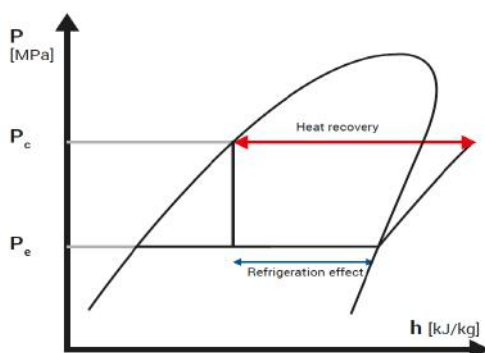

The solution proposed by Euroklimat for Total Heat Recovery is a modulating solution, based on the concept that the recovery load may vary during the function of the unit and, as a consequence, there could be:

- A total rejection of the condenser heat to the environment (0% heat recovery).
- A partial recovery of the available condenser heat (variable from 0% to 100%).
- Total recovery of the heat (100% heat recovery).

Why choosing Modulating Heat Recovery?

- Innovative solution.
- Dedicated software.
- Possibility to adapt and modulate the heat production according to requested thermal loads.

CRIO BS

7-1-1 PE ↔ 173-2-2 PE



Refrigerant
R290 | GWP=3



Braze plate
heat exchanger



Semi-hermetic
piston compressor



Axial fan



Cu/Al
condensing coils



SEPR

Air to water chillers for medium temperature applications

Standard efficiency



Solution

B - Base
I - Integrata

Version

ST - Standard
LN - Low Noise
SL - Super Low Noise

Equipment

AS - Standard equipment
DS - Desuperheater
HR - Total modulating Heat Recovery

Cooling capacity 7 - 164 kW

Safety system	To ensure high-safety-level the unit is equipped with an ATEX certified gas detector and an EC centrifugal extraction fan . The sensor, with external dedicated power supply and Modbus output signal, has an alarm threshold set at 10% of the lower flammable limit (LFL). The Propane alarm causes the immediate shutdown of the machine and the centrifugal extraction fan is switched on, which allows the ventilation of the compressor compartment and the dilution of the R290 concentration to values below the lower flammability limit.
Structure	Structure specifically designed and built to guarantee total resistance to atmospheric agents and corrosion. Basement and panels made of galvanized steel sheet, oven-painted with polyurethane powders. Frame made of anodized aluminium profiles, with aluminium alloy corner joints that guarantee excellent mechanical resistance and low weight. LN (Low Noise) version: the panels are internally lined with sound-absorbing material. SL (Super Low Noise) version: the panels are sandwich and insulated with rock wool.
Compressor	Reciprocating semi-hermetic type compressor equipped with: electronic control module and protection of the electric motor (installed inside the electrical panel); oil charge; oil level sight glass and oil crankcase heater; anti-vibration rubber supports; anti-vibration pipes (suction and discharge); suction and discharge valves. The compressor can be supplied with one or more RSH capacity control heads to guarantee an adaptation of the cooling capacity in case of thermal load's reduction: please see the list of accessories for further information.
EC Fan	Premium-Axial-Fans with bionic shaped blades and high-efficient EC (Electronically Commutated) external rotor motors, sealed in protection IP54 and thermal class THCL 155. The motor efficiency class complies with IE4.
Air heat exchanger	Finned coil made with copper pipes arranged on staggered rows, mechanically expanded inside a pack of aluminium fins offering a high exchange surface area.
Water heat exchanger	Braze plate-type heat exchanger, stainless steel AISI 316 made, complete with water differential pressure switch, air vent valve and thermally insulated with closed-cell neoprene anti-condensate material. The heat exchanger design provides high thermal exchange and high performance results, furthermore it guarantees small dimensions and easy installation and maintenance.
Electrical board	Each unit is equipped with electric panel, built, wired and fully tested at the factory. Wiring numeration and optimized layout facilitate troubleshooting. The installed components are identified by nameplates to better identify the application and the type of action. Switchboard is made according to standards IEC 204-1/EN60204-1 and it is complete with the following main components: - Main isolator switch - Door interlock safety device - Contactor and protection for compressor and fans - Cabinet minimum protection rating IP54. To ensure higher level of security, the cabinet is outside the machine and positioned on one side of the unit. The propane sensor is equipped with separate power supply: this power supply must always be guaranteed in order to ensure the monitoring of any leakage.
Control	The microprocessor controls the unit capacity by timing the compressors and checks the operating alarms with the possibility to connect to BMS.
Refrigerant circuit	Filter drier, moisture-liquid sight glass, electronic expansion valve, high & low pressure gauge, high and low pressure transducers, high pressure switch, safety high pressure valve (when required by EN 378-2016 standard).
Water circuit (Integrata)	Base version: as interface to the plant, includes the water fittings of the evaporator only. Integrated version: Water storage tank, water pressure gauge, safety valve, water discharge valve, centrifugal pump(s) suitable for glycol solutions up to 40%, manual by-pass valve, manual air venting valve. The pump control equipment is fitted inside the electrical board of the unit and the microprocessor control manages the pump starting, timing and all the safety devices of the whole system.

ACCESSORI PRINCIPALI

- Anti-vibration rubber/spring mounts
- Air heat exchanger protection panel or filter
- Air heat exchanger with various coatings treatment
- Low pressure switch
- Low pressure safety valve
- Double safety valve
- Overpressure valve / automatic by-pass
- Double water pump (stand-by) - Standard/ High pressure
- Open / Closed expansion vessel with automatic filling unit
- RSH Capacity Control head / Inverter driven compressor
- Advanced control c.pCo

CRIO BS

Technical data

CRIO BS R290 range		7-1-1 PE	9-1-1 PE	12-1-1 PE	17-1-1 PE	19-1-1 PE
COOLING - A BP/ST/AS/EC/*S version						
Cooling capacity ⁽¹⁾	[kW]	6,70	8,16	11,0	16,3	19,0
Total power input ⁽¹⁾	[kW]	4,05	4,50	6,52	8,37	10,0
EER - Energy Efficiency Ratio	-	1,65	1,81	1,69	1,95	1,90
Saved CO2 equivalent Ton (*)	[CO ₂ Ton]	3,4	5,4	6,0	10,2	11,3
"Ecodesign" compliance for process application (SEPR)	-	2,86	3,05	2,70	3,34	3,22

REFRIGERANT CIRCUIT						
Refrigerant	-	R290				
GWP	-	3				
Charge of refrigerant - Base unit	[kg]	0,9	1,4	1,6	2,6	2,9
Independent gas circuits	[n°]	1				
Compressors type	-	Semi-hermetic pistons				
Compressors quantity	[n°]	1				
Steps of capacity for each compressor (std)	-	1 (50%)	1 (75%); 2 (50%)			
Condensing coils type	-	Cu/Al				
Fans type	-	Axial EC				
Fans quantity	[n°]	1				
Fans power input ⁽¹⁾ (total)	[kW]	0,50	0,50	0,50	0,81	0,81
Total air flow	[m ³ /h]	4.300	6.300	6.300	12.500	12.500
Expansion valve type	-	Electronic				
Evaporator water flow ⁽¹⁾	[m ³ /h]	1,65	2,00	2,71	4,01	4,65
User circuit pressure drop ⁽¹⁾	[kPa]	28,1	20,2	20,6	27,4	26,5

DESUPERHEATER (option) - A BP/ST/DS/EC/*S						
Heating capacity ⁽²⁾	[kW]	1,79	1,99	3,07	3,53	4,35
Water flow	[m ³ /h]	0,31	0,35	0,54	0,61	0,76
User circuit pressure drop	[kPa]	2,3	2,7	2,5	2,2	2,6

HEAT RECOVERY (option) - A BP/ST/HR/EC/*S						
Heating capacity ⁽²⁾	[kW]	10,50	12,40	17,70	24,20	28,90
Water flow	[m ³ /h]	1,82	2,16	3,06	4,18	5,00
User circuit pressure drop	[kPa]	19,5	13,9	24,3	27,2	27,1

Electrical data						
Power supply	-	400/3/50				
Emergency power supply	-	230/1/50				
Maximum power input without pump	[kW]	7,00	8,70	12,5	14,1	16,6
Locked rotor current – LRA without pump	[A]	52,9	64,1	88,3	104	119
Maximum absorbed current - FLA without pump	[A]	12,7	14,8	21,6	23,5	30,6

HYDRONIC KIT (option)						
Buffer tank capacity	[L]	30	30	30	60	60
Pump type	-	Centrifugal				

Standard pump - 150 kPa useful head						
Motor Efficiency	-	-	-	-	-	-
Pump motor nominal power	[kW]	0,37	0,37	0,37	0,55	0,55
Pump motor nominal current	[A]	1,4	1,4	1,4	1,9	1,9

Standard pump - 250 kPa useful head						
Motor Efficiency	-	-	-	IE3	IE3	IE3
Pump motor nominal power	[kW]	0,55	0,55	0,75	0,9	0,9
Pump motor nominal current	[A]	2	2	1,9	2,5	2,5

Water connections						
Dimension (nominal external diameter)	[inch/DN]	1/2" (DN15)	1/2" (DN15)	1" (DN 25)	1" (DN 25)	1" (DN 25)

Noise levels ⁽³⁾						
Total sound power (ST version)	[db(A)]	82	79	79	82	83
Total sound pressure (ST version) - at 1 m distance	[db(A)]	67	63	63	65	66
Total sound pressure (ST version) - at 10 m distance	[db(A)]	51	48	48	51	52
Total sound power (LN version)	[db(A)]	79	76	76	79	80
Total sound pressure (LN version) - at 1 m distance	[db(A)]	64	60	60	62	63
Total sound pressure (LN version) - at 10 m distance	[db(A)]	48	45	45	48	49
Total sound power (SL version)	[db(A)]	77	74	74	77	78
Total sound pressure (SL version) - at 1 m distance	[db(A)]	62	58	58	60	61
Total sound pressure (SL version) - at 10 m distance	[db(A)]	46	43	43	46	47

Reference conditions:

(1) Condenser air intake temperature = 35 °C - Evaporator fluid temperature IN/OUT = -4/-8 °C; Fluid: MEG 35% - Condensing coil: Cu/Al or microchannel according to models. Results according to UNI EN 14511-2022.

(2) Condenser air intake temperature = 35 °C - Evaporator fluid temperature IN/OUT = -4/-8 °C; Fluid: MEG 35% - Recovery user temp. IN/OUT = 40/45 °C; Fluid: water - Condensing coil: Cu/Al or microchannel according to models. Result according to UNI EN 14511-2022.

(3) Sound power level in compliance with ISO 3744 - Sound pressure level (average) at 10 meter distance, unit in a free field on a reflective surface; non-binding value obtained from the sound power level.

(*) CO2 equivalent tons saved to the Environment compared to the choice of an EUROKLIMAT unit with similar cooling capacity and HFC refrigerant

CRIO BS

Technical data

CRIO BS R290 range		23-1-1 PE	28-1-1 PE	33-1-1 PE	39-1-1 PE	48-1-1 PE
COOLING - A BP/ST/AS/EC/*S version						
Cooling capacity ⁽¹⁾	[kW]	21,1	25,7	29,7	36,7	47,2
Total power input ⁽¹⁾	[kW]	10,5	13,4	16,6	19,0	24,9
EER - Energy Efficiency Ratio	-	2,01	1,92	1,79	1,93	1,90
Saved CO2 equivalent Ton (*)	[CO ₂ Ton]	13,3	14,2	17,7	19,9	25,3
"Ecodesign" compliance for process application (SEPR)	-	3,07	3,04	2,90	3,06	3,35

REFRIGERANT CIRCUIT						
Refrigerant	-	R290				
GWP	-	3				
Charge of refrigerant - Base unit	[kg]	3,5	3,7	4,6	5,2	6,6
Independent gas circuits	[n°]	1				
Compressors type	-	Semi-hermetic pistons				
Compressors quantity	[n°]	1				
Steps of capacity for each compressor (std)	-	1 (75%); 2 (50%)			1 (83%); 2 (67%); 3 (50%)	
Condensing coils type	-	Cu/Al				
Fans type	-	Axial EC				
Fans quantity	[n°]	1			2	
Fans power input ⁽¹⁾ (total)	[kW]	0,84	0,84	1,70	1,70	4,23
Total air flow	[m ³ /h]	11.800	11.800	23.500	23.500	40.400
Expansion valve type	-	Electronic				
Evaporator water flow ⁽¹⁾	[m ³ /h]	5,18	6,30	7,28	8,98	11,6
User circuit pressure drop ⁽¹⁾	[kPa]	24,6	27,6	29,4	21,8	27,0

DESUPERHEATER (option) - A BP/ST/DS/EC/*S						
Heating capacity ⁽²⁾	[kW]	4,35	5,94	6,92	7,94	8,73
Water flow	[m ³ /h]	0,75	1,03	1,20	1,39	1,51
User circuit pressure drop	[kPa]	2,5	2,4	2,8	2,7	2,5

HEAT RECOVERY (option) - A BP/ST/HR/EC/*S						
Heating capacity ⁽²⁾	[kW]	30,7	39,3	45,7	55,2	68,3
Water flow	[m ³ /h]	5,32	6,81	7,92	9,55	11,8
User circuit pressure drop	[kPa]	23,7	30,1	33,7	41,5	29,9

Electrical data						
Power supply	-	400/3/50				
Emergency power supply	-	230/1/50				
Maximum power input without pump	[kW]	19,1	21,4	27,5	34,1	42,6
Locked rotor current – LRA without pump	[A]	138	205	228	243	282
Maximum absorbed current - FLA without pump	[A]	37,8	38,8	47,8	57,7	70,3

HYDRONIC KIT (option)						
Buffer tank capacity	[L]	60	60	160	160	290
Pump type	-	Centrifugal				

Standard pump - 150 kPa useful head						
Motor Efficiency	-	-	IE3			
Pump motor nominal power	[kW]	0,55	0,9	0,9	0,9	1,1
Pump motor nominal current	[A]	1,9	2,5	2,5	2,5	3,3

Standard pump - 250 kPa useful head						
Motor Efficiency	-	IE3				
Pump motor nominal power	[kW]	1,5	1,5	1,5	1,5	2,2
Pump motor nominal current	[A]	4,1	4,1	4,1	4,1	4,7

Water connections						
Dimension (nominal external diameter)	[inch/DN]	1" (DN 25)	1" 1/2 (DN 40)	1" 1/2 (DN 40)	1" 1/2 (DN 40)	1" 1/2 (DN 40)

Noise levels ⁽³⁾						
Total sound power (ST version)	[db(A)]	84	84	87	88	87
Total sound pressure (ST version) - at 1 m distance	[db(A)]	67	67	70	71	69
Total sound pressure (ST version) - at 10 m distance	[db(A)]	53	53	56	57	56
Total sound power (LN version)	[db(A)]	81	81	84	85	84
Total sound pressure (LN version) - at 1 m distance	[db(A)]	64	64	67	68	66
Total sound pressure (LN version) - at 10 m distance	[db(A)]	50	50	53	54	53
Total sound power (SL version)	[db(A)]	79	79	82	83	82
Total sound pressure (SL version) - at 1 m distance	[db(A)]	62	62	65	66	64
Total sound pressure (SL version) - at 10 m distance	[db(A)]	48	48	51	52	51

Reference conditions:

(1) Condenser air intake temperature = 35 °C - Evaporator fluid temperature IN/OUT = -4/-8 °C; Fluid: MEG 35% - Condensing coil: Cu/Al or microchannel according to models. Results according to UNI EN 14511-2022.

(2) Condenser air intake temperature = 35 °C - Evaporator fluid temperature IN/OUT = -4/-8 °C; Fluid: MEG 35% - Recovery user temp. IN/OUT = 40/45 °C; Fluid: water - Condensing coil: Cu/Al or microchannel according to models. Result according to UNI EN 14511-2022.

(3) Sound power level in compliance with ISO 3744 - Sound pressure level (average) at 10 meter distance, unit in a free field on a reflective surface; non-binding value obtained from the sound power level.

(*) CO2 equivalent tons saved to the Environment compared to the choice of an EUROLIMAT unit with similar cooling capacity and HFC refrigerant

CRIO BS

Technical data

CRIO BS R290 range		55-1-1 PE	38-2-2 PE	49-2-2 PE	58-2-2 PE
COOLING - A BP/ST/AS/EC/*S version					
Cooling capacity ⁽¹⁾	[kW]	53,9	35,5	47,4	52,7
Total power input ⁽¹⁾	[kW]	29,7	20,4	24,8	29,2
EER - Energy Efficiency Ratio	-	1,81	1,74	1,91	1,80
Saved CO2 equivalent Ton (*)	[CO ₂ Ton]	26,1	20,4	26,3	28,3
"Ecodesign" compliance for process application (SEPR)	-	3,19	3,00	3,49	3,16

REFRIGERANT CIRCUIT					
Refrigerant	-	R290			
GWP	-	3			
Charge of refrigerant - Base unit	[kg]	6,8	5,3	6,8	7,4
Independent gas circuits	[n°]	1	2		
Compressors type	-	Semi-hermetic pistons			
Compressors quantity	[n°]	1	2		
Steps of capacity for each compressor (std)	-	1 (83%); 2 (67%); 3 (50%)	1 (75%); 2 (50%)		
Condensing coils type	-	Cu/Al			
Fans type	-	Axial Ec			
Fans quantity	[n°]	2			
Fans power input ⁽³⁾ (total)	[kW]	2,97	1,67	4,26	4,25
Total air flow	[m ³ /h]	40.400	24.100	39.900	39.900
Expansion valve type	-	Electronic			
Evaporator water flow ⁽¹⁾	[m ³ /h]	13,2	8,69	11,6	12,9
User circuit pressure drop ⁽¹⁾	[kPa]	28,0	26,8	28,3	23,6

DESUPERHEATER (option) - A BP/ST/DS/EC/*S					
Heating capacity ⁽²⁾	[kW]	11,6	9,53	8,62	11,3
Water flow	[m ³ /h]	2,02	1,64	1,50	1,97
User circuit pressure drop	[kPa]	2,7	4,0	4,2	4,9

HEAT RECOVERY (option) - A BP/ST/HR/EC/*S					
Heating capacity ⁽²⁾	[kW]	80,5	56,8	68,4	79,0
Water flow	[m ³ /h]	14,0	9,84	11,8	13,7
User circuit pressure drop	[kPa]	31	22,9	30,5	37,9

Electrical data					
Power supply	-	400/3/50			
Emergency power supply	-	230/1/50			
Maximum power input without pump	[kW]	50,2	33,1	38,6	46,4
Locked rotor current – LRA without pump	[A]	331	150	220	249
Maximum absorbed current - FLA without pump	[A]	83,9	61,2	69,7	83,1

HYDRONIC KIT (option)					
Buffer tank capacity	[L]	290	160	160	160
Pump type	-	Centrifugal			

Standard pump - 150 kPa useful head					
Motor Efficiency	-	IE3			
Pump motor nominal power	[kW]	1,1	0,9	1,1	1,1
Pump motor nominal current	[A]	3,3	2,5	3,3	3,3

Standard pump - 250 kPa useful head					
Motor Efficiency	-	IE3			
Pump motor nominal power	[kW]	2,2	1,5	2,2	2,2
Pump motor nominal current	[A]	4,7	4,1	4,7	4,7

Water connections					
Dimension (nominal external diameter)	[inch/DN]	1" 1/2 (DN 40)	1" 1/2 (DN 40)	1" 1/2 (DN 40)	2" (DN 50)

Noise levels ⁽³⁾					
Total sound power (ST version)	[db(A)]	87	87	86	86
Total sound pressure (ST version) - at 1 m distance	[db(A)]	69	70	69	69
Total sound pressure (ST version) - at 10 m distance	[db(A)]	56	56	56	56
Total sound power (LN version)	[db(A)]	84	84	83	83
Total sound pressure (LN version) - at 1 m distance	[db(A)]	66	67	66	66
Total sound pressure (LN version) - at 10 m distance	[db(A)]	53	53	53	53
Total sound power (SL version)	[db(A)]	82	82	81	81
Total sound pressure (SL version) - at 1 m distance	[db(A)]	64	65	64	64
Total sound pressure (SL version) - at 10 m distance	[db(A)]	51	51	51	51

Reference conditions:

(1) Condenser air intake temperature = 35 °C - Evaporator fluid temperature IN/OUT = -4/-8 °C; Fluid: MEG 35% - Condensing coil: Cu/Al or microchannel according to models. Results according to UNI EN 14511-2022.

(2) Condenser air intake temperature = 35 °C - Evaporator fluid temperature IN/OUT = -4/-8 °C; Fluid: MEG 35% - Recovery user temp. IN/OUT = 40/45 °C; Fluid: water - Condensing coil: Cu/Al or microchannel according to models. Results according to UNI EN 14511-2022.

(3) Sound power level in compliance with ISO 3744 - Sound pressure level (average) at 10 meter distance, unit in a free field on a reflective surface; non-binding value obtained from the sound power level.

(*) CO2 equivalent tons saved to the Environment compared to the choice of an EUROKLIMAT unit with similar cooling capacity and HFC refrigerant

CRIO BS

Technical data

CRIO BS R290 range		68-2-2 PE	79-2-2 PE	95-2-2 PE	108-2-2 PE
COOLING - A BP/ST/AS/EC/*S version					
Cooling capacity ⁽¹⁾	[kW]	61,8	74,6	93,1	106
Total power input ⁽¹⁾	[kW]	34,1	41,1	48,7	58,8
EER - Energy Efficiency Ratio	-	1,81	1,82	1,91	1,80
Saved CO2 equivalent Ton (*)	[CO ₂ Ton]	36,3	38,1	47,8	49,6
"Ecodesign" compliance for process application (SEPR)	-	2,92	3,12	3,21	3,03

REFRIGERANT CIRCUIT					
Refrigerant	-	R290			
GWP	-	3			
Charge of refrigerant - Base unit	[kg]	9,4	9,9	12,4	12,9
Independent gas circuits	[n°]	2			
Compressors type	-	Semi-hermetic pistons			
Compressors quantity	[n°]	2			
Steps of capacity for each compressor (std)	-	1 (75%); 2 (50%)	1 (83%); 2 (67%); 3 (50%)		
Condensing coils type	-	Cu/Al			
Fans type	-	Axial Ec			
Fans quantity	[n°]	2	3		
Fans power input ⁽³⁾ (total)	[kW]	4,38	6,41	6,62	6,59
Total air flow	[m ³ /h]	37.400	59.400	55.300	55.300
Expansion valve type	-	Electronic			
Evaporator water flow ⁽¹⁾	[m ³ /h]	15,1	18,3	22,8	25,9
User circuit pressure drop ⁽¹⁾	[kPa]	24,5	32,7	38,5	40,0

DESUPERHEATER (option) - A BP/ST/DS/EC/*S					
Heating capacity ⁽²⁾	[kW]	13,6	15,5	18,6	24,8
Water flow	[m ³ /h]	2,36	2,68	3,20	4,31
User circuit pressure drop	[kPa]	5,7	4,6	4,7	4,9

HEAT RECOVERY (option) - A BP/ST/HR/EC/*S					
Heating capacity ⁽²⁾	[kW]	92,7	111	137	161
Water flow	[m ³ /h]	16,1	19,2	23,7	27,9
User circuit pressure drop	[kPa]	32,8	31,3	36,5	39,7

Electrical data					
Power supply	-	400/3/50			
Emergency power supply	-	230/1/50			
Maximum power input without pump	[kW]	56,4	72,6	82,2	97,4
Locked rotor current – LRA without pump	[A]	278	307	348	410
Maximum absorbed current - FLA without pump	[A]	97,3	122	136	163

HYDRONIC KIT (option)					
Buffer tank capacity	[L]	160	290	290	290
Pump type	-	Centrifugal			

Standard pump - 150 kPa useful head					
Motor Efficiency	-	IE3			
Pump motor nominal power	[kW]	2,2	2,2	2,2	2,2
Pump motor nominal current	[A]	4,7	4,7	4,7	4,7

Standard pump - 250 kPa useful head					
Motor Efficiency	-	IE3			
Pump motor nominal power	[kW]	2,2	3	3	4
Pump motor nominal current	[A]	4,7	6,4	6,4	8,7

Water connections					
Dimension (nominal external diameter)	[inch/DN]	2" (DN 50)	2" (DN 50)	2"1/2 (DN 65)	2"1/2 (DN 65)

Noise levels ⁽³⁾					
Total sound power (ST version)	[db(A)]	88	89	91	91
Total sound pressure (ST version) - at 1 m distance	[db(A)]	70	71	73	73
Total sound pressure (ST version) - at 10 m distance	[db(A)]	57	57	59	59
Total sound power (LN version)	[db(A)]	85	86	88	88
Total sound pressure (LN version) - at 1 m distance	[db(A)]	67	68	70	70
Total sound pressure (LN version) - at 10 m distance	[db(A)]	54	54	56	56
Total sound power (SL version)	[db(A)]	83	84	86	86
Total sound pressure (SL version) - at 1 m distance	[db(A)]	65	66	68	68
Total sound pressure (SL version) - at 10 m distance	[db(A)]	52	52	54	54

Reference conditions:

(1) Condenser air intake temperature = 35 °C - Evaporator fluid temperature IN/OUT = -4/-8 °C; Fluid: MEG 35% - Condensing coil: Cu/Al or microchannel according to models. Results according to UNI EN 14511-2022.

(2) Condenser air intake temperature = 35 °C - Evaporator fluid temperature IN/OUT = -4/-8 °C; Fluid: MEG 35% - Recovery user temp. IN/OUT = 40/45 °C; Fluid: water - Condensing coil: Cu/Al or microchannel according to models. Results according to UNI EN 14511-2022.

(3) Sound power level in compliance with ISO 3744 - Sound pressure level (average) at 10 meter distance, unit in a free field on a reflective surface; non-binding value obtained from the sound power level.

(*) CO2 equivalent tons saved to the Environment compared to the choice of an EUROKLIMAT unit with similar cooling capacity and HFC refrigerant

CRIO BS

Technical data

CRIO BS R290 range		126-2-2 PE	137-2-2 PE	157-2-2 PE	173-2-2 PE
COOLING - A BP/ST/AS/EC/*S version					
Cooling capacity ⁽¹⁾	[kW]	119	127	153	164
Total power input ⁽¹⁾	[kW]	62,30	68,00	77,10	82,10
EER - Energy Efficiency Ratio	-	1,91	1,87	1,98	2,00
Saved CO2 equivalent Ton (*)	[CO ₂ Ton]	70,8	73,5	98,2	102
"Ecodesign" compliance for process application (SEPR)	-	3,17	3,07	3,19	3,26

REFRIGERANT CIRCUIT					
Refrigerant	-	R290			
GWP	-	3			
Charge of refrigerant - Base unit	[kg]	18,4	19,1	25,5	26,5
Independent gas circuits	[n°]	2			
Compressors type	-	Semi-hermetic pistons			
Compressors quantity	[n°]	2			
Steps of capacity for each compressor (std)	-	2 (75%); 3 (62,5%); 4 (50%)			
Condensing coils type	-	Cu/Al			
Fans type	-	Axial EC			
Fans quantity	[n°]	3		4	
Fans power input ⁽³⁾ (total)	[kW]	5,8	5,79	7,91	7,9
Total air flow	[m ³ /h]	68.300	68.300	88.600	88.600
Expansion valve type	-	Electronic			
Evaporator water flow ⁽¹⁾	[m ³ /h]	29,1	31,2	37,5	40,2
User circuit pressure drop ⁽¹⁾	[kPa]	41,8	41,7	42,6	37,2

DESUPERHEATER (option) - A BP/ST/DS/EC/*S					
Heating capacity ⁽²⁾	[kW]	26,7	29,7	31,6	34,2
Water flow	[m ³ /h]	4,58	5,16	5,52	5,99
User circuit pressure drop	[kPa]	4,2	4,4	12,4	12,7

HEAT RECOVERY (option) - A BP/ST/HR/EC/*S					
Heating capacity ⁽²⁾	[kW]	177	193	220	237
Water flow	[m ³ /h]	30,7	33,5	38,1	41,0
User circuit pressure drop	[kPa]	40,0	46,0	50,7	52,1

Electrical data					
Power supply	-	400/3/50			
Emergency power supply	-	230/1/50			
Maximum power input without pump	[kW]	92,0	111	114	119
Locked rotor current – LRA without pump	[A]	386	468	559	661
Maximum absorbed current - FLA without pump	[A]	161	189	189	207

HYDRONIC KIT (option)					
Buffer tank capacity	[L]	500	500	470	470
Pump type	-	Centrifugal			

Standard pump - 150 kPa useful head					
Motor Efficiency	-	IE3			
Pump motor nominal power	[kW]	3	3	3	3
Pump motor nominal current	[A]	6,4	6,4	6,4	6,4

Standard pump - 250 kPa useful head					
Motor Efficiency	-	IE3			
Pump motor nominal power	[kW]	4	4	5,5	5,5
Pump motor nominal current	[A]	8,7	8,7	10,6	10,6

Water connections					
Dimension (nominal external diameter)	[inch/DN]	3" (DN 80)	3" (DN 80)	3" (DN 80)	3" (DN 80)

Noise levels ⁽³⁾					
Total sound power (ST version)	[dB(A)]	90	94	95	95
Total sound pressure (ST version) - at 1 m distance	[dB(A)]	71	75	76	76
Total sound pressure (ST version) - at 10 m distance	[dB(A)]	58	62	63	63
Total sound power (LN version)	[dB(A)]	87	91	92	92
Total sound pressure (LN version) - at 1 m distance	[dB(A)]	68	72	73	73
Total sound pressure (LN version) - at 10 m distance	[dB(A)]	55	59	60	60
Total sound power (SL version)	[dB(A)]	85	89	90	90
Total sound pressure (SL version) - at 1 m distance	[dB(A)]	66	70	71	71
Total sound pressure (SL version) - at 10 m distance	[dB(A)]	53	57	58	58

Reference conditions:

(1) Condenser air intake temperature = 35 °C - Evaporator fluid temperature IN/OUT = -4/-8 °C; Fluid: MEG 35% - Condensing coil: Cu/Al or microchannel according to models. Results according to UNI EN 14511-2022.

(2) Condenser air intake temperature = 35 °C - Evaporator fluid temperature IN/OUT = -4/-8 °C; Fluid: MEG 35% - Recovery user temp. IN/OUT = 40/45 °C; Fluid: water - Condensing coil: Cu/Al or microchannel according to models. Results according to UNI EN 14511-2022.

(3) Sound power level in compliance with ISO 3744 - Sound pressure level (average) at 10 meter distance, unit in a free field on a reflective surface; non-binding value obtained from the sound power level.

(*) CO2 equivalent tons saved to the Environment compared to the choice of an EUROKLIMAT unit with similar cooling capacity and HFC refrigerant

CRIO BS

158-2-2 PV ↔ 182-2-2 PV



Refrigerant
R290 | GWP=3



Brazen plate
heat exchanger



Semi-hermetic
piston compressor



Axial fan



Microchannel
condensing coils



Air to water chillers for medium temperature applications
Standard efficiency



Solution

B - Base
I - Integrata

Version

ST - Standard
LN - Low Noise
SL - Super Low Noise

Equipment

AS - Standard equipment
DS - Desuperheater
HR - Total modulating Heat Recovery

Cooling capacity 156 - 174 kW

Safety system

To ensure high-safety-level the unit is equipped with an **ATEX certified gas detector** and an **EC centrifugal extraction fan**. The sensor, with external dedicated power supply and Modbus output signal, has an alarm threshold set at 10% of the lower flammable limit (LFL). The Propane alarm causes the immediate shutdown of the machine and the centrifugal extraction fan is switched on, which allows the ventilation of the compressor compartment and the dilution of the R290 concentration to values below the lower flammability limit.

Structure

Structure specifically designed and built to guarantee total resistance to atmospheric agents and corrosion. Basement and panels made of galvanized steel sheet, oven-painted with polyurethane powders. Frame made of anodized aluminium profiles, with aluminium alloy corner joints that guarantee excellent mechanical resistance and low weight. LN (Low Noise) version: the panels are internally lined with sound-absorbing material. SL (Super Low Noise) version: the panels are sandwich and insulated with rock wool.

Compressor

Reciprocating semi-hermetic type compressor equipped with: electronic control module and protection of the electric motor (installed inside the electrical panel); oil charge; oil level sight glass and oil crankcase heater; anti-vibration rubber supports; anti-vibration pipes (suction and discharge); suction and discharge valves. The compressor can be supplied with one or more RSH capacity control heads to guarantee an adaptation of the cooling capacity in case of thermal load's reduction: please see the list of accessories for further information.

EC Fan

Premium-Axial-Fans with bionic shaped blades and high-efficient EC (Electronically Commutated) external rotor motors, sealed in protection IP54 and thermal class THCL 155. The motor efficiency class complies with IE4.

Air heat exchanger

Microchannel technology increases the primary to secondary surface area ratio and reduces the tube's air shadow to provide maximum heat exchange through our condensers.

Water heat exchanger

Brazen plate-type heat exchanger, stainless steel AISI 316 made, complete with water differential pressure switch, air vent valve and thermally insulated with closed-cell neoprene anti-condensate material. The heat exchanger design provides high thermal exchange and high performance results, furthermore it guarantees small dimensions and easy installation and maintenance.

Electrical board

Each unit is equipped with electric panel, built, wired and fully tested at the factory. Wiring numeration and optimized layout facilitate troubleshooting. The installed components are identified by nameplates to better identify the application and the type of action. Switchboard is made according to standards IEC 204-1/EN60204-1 and it is complete with the following main components: - Main isolator switch - Door interlock safety device - Contactor and protection for compressor and fans - Cabinet minimum protection rating IP54.

To ensure higher level of security, the cabinet is outside the machine and positioned on one side of the unit. The propane sensor is equipped with separate power supply: this power supply must always be guaranteed in order to ensure the monitoring of any leakage.

Control

The microprocessor controls the unit capacity by timing the compressors and checks the operating alarms with the possibility to connect to BMS.

Refrigerant circuit

Filter drier, moisture-liquid sight glass, electronic expansion valve, high & low pressure gauge, high and low pressure transducers, high pressure switch, safety high pressure valve (when required by EN 378-2016 standard).

Water circuit

(Integrata)

Base version: as interface to the plant, includes the water fittings of the evaporator only.

Integrated version: Water storage tank, water pressure gauge, safety valve, water discharge valve, centrifugal pump(s) suitable for glycol solutions up to 40%, manual by-pass valve, manual air venting valve. The pump control equipment is fitted inside the electrical board of the unit and the microprocessor control manages the pump starting, timing and all the safety devices of the whole system.

ACCESSORI PRINCIPALI

- Anti-vibration rubber/spring mounts
- Air heat exchanger protection panel or filter
- Air heat exchanger with various coatings treatment
- Low pressure switch
- Low pressure safety valve
- Double safety valve
- Overpressure valve / automatic by-pass
- Double water pump (stand-by) - Standard/ High pressure
- Open / Closed expansion vessel with automatic filling unit
- RSH Capacity Control head / Inverter driven compressor
- Advanced control c.pCo

CRIO BS

Technical data

CRIO BS R290 range		158-2-2 PV	174-2-2 PV	182-2-2 PV
COOLING - A BP/ST/AS/EC/*S version				
Cooling capacity ⁽¹⁾	[kW]	156	167	174
Total power input ⁽¹⁾	[kW]	76,7	81,3	90,4
EER - Energy Efficiency Ratio	-	2,03	2,05	1,92
Saved CO2 equivalent Ton (*)	[CO ₂ Ton]	64,6	69,5	69,5
"Ecodesign" compliance for process application (SEPR)	-	3,19	3,26	2,97

REFRIGERANT CIRCUIT				
Refrigerant	-	R290		
GWP	-	3		
Charge of refrigerant - Base unit	[kg]	16,8	18,1	18,1
Independent gas circuits	[n°]	2		
Compressors type	-	Semi-hermetic pistons		
Compressors quantity	[n°]	2		
Steps of capacity for each compressor (std)	-	2 (75%); 3 (62,5%); 4 (50%)		
Condensing coils type	-	Microchannel		
Fans type	-	Axial EC		
Fans quantity	[n°]	4		
Fans power input ⁽¹⁾ (total)	[kW]	7,74	7,69	7,68
Total air flow	[m ³ /h]	91.100	91.600	91.600
Expansion valve type	-	Electronic		
Evaporator water flow ⁽¹⁾	[m ³ /h]	38,1	40,9	42,5
User circuit pressure drop ⁽¹⁾	[kPa]	43,6	38,3	40,5

DESUPERHEATER (option) - A BP/ST/DS/EC/*S				
Heating capacity ⁽²⁾	[kW]	31,0	33,2	39,5
Water flow	[m ³ /h]	5,37	5,78	6,87
User circuit pressure drop	[kPa]	11,9	12,1	14,9

HEAT RECOVERY (option) - A BP/ST/HR/EC/*S				
Heating capacity ⁽²⁾	[kW]	220	236	254
Water flow	[m ³ /h]	38,1	40,9	44,1
User circuit pressure drop	[kPa]	50,7	51,9	39,8

Electrical data				
Power supply	-	400/3/50		
Emergency power supply	-	230/1/50		
Maximum power input without pump	[kW]	114	119	127
Locked rotor current – LRA without pump	[A]	559	661	704
Maximum absorbed current - FLA without pump	[A]	189	207	222

HYDRONIC KIT (option)				
Buffer tank capacity	[L]	290	290	290
Pump type	-	Centrifugal		

Standard pump - 150 kPa useful head				
Motor Efficiency	-	IE3		
Pump motor nominal power	[kW]	3	3	3
Pump motor nominal current	[A]	6,4	6,4	6,4

Standard pump - 250 kPa useful head				
Motor Efficiency	-	IE3		
Pump motor nominal power	[kW]	5,5	5,5	5,5
Pump motor nominal current	[A]	10,6	10,6	10,6

Water connections				
Dimension (nominal external diameter)	[inch/DN]	3" (DN 80)	3" (DN 80)	3" (DN 80)

Noise levels ⁽³⁾				
Total sound power (ST version)	[db(A)]	95	95	97
Total sound pressure (ST version) - at 1 m distance	[db(A)]	76	76	78
Total sound pressure (ST version) - at 10 m distance	[db(A)]	63	63	65
Total sound power (LN version)	[db(A)]	92	92	94
Total sound pressure (LN version) - at 1 m distance	[db(A)]	73	73	75
Total sound pressure (LN version) - at 10 m distance	[db(A)]	60	60	62
Total sound power (SL version)	[db(A)]	90	90	92
Total sound pressure (SL version) - at 1 m distance	[db(A)]	71	71	73
Total sound pressure (SL version) - at 10 m distance	[db(A)]	58	58	60

Reference conditions:

(1) Condenser air intake temperature = 35 °C - Evaporator fluid temperature IN/OUT = -4/-8 °C; Fluid: MEG 35% - Condensing coil: Cu/Al or microchannel according to models. Results according to UNI EN 14511-2022.

(2) Condenser air intake temperature = 35 °C - Evaporator fluid temperature IN/OUT = -4/-8 °C; Fluid: MEG 35% - Recovery user temp. IN/OUT = 40/45 °C; Fluid: water - Condensing coil: Cu/Al or microchannel according to models. Result: according to UNI EN 14511-2022.

(3) Sound power level in compliance with ISO 3744 - Sound pressure level (average) at 10 meter distance, unit in a free field on a reflective surface; non-binding value obtained from the sound power level.

(*) CO2 equivalent tons saved to the Environment compared to the choice of an EUROLIMAT unit with similar cooling capacity and HFC refrigerant

CRIO BS

Dimensions and weights

CRIO BS R290 range		7-1-1 PE	9-1-1 PE	12-1-1 PE	17-1-1 PE	19-1-1 PE	23-1-1 PE
DIMENSIONS AND WEIGHTS - Standard unit							
Lenght	[mm]	1230	1380	1380	1680	1680	1680
Width	[mm]	685	835	835	1025	1025	1025
Height (ST - LN)	[mm]	1405	1820	1820	2121	2121	2121
Height (SL)	[mm]	-	-	-	2208	2208	2208
Shipping weight (A BP/ST/AS/EC/** version)	[kg]	190	300	300	410	420	440
Operating weight (A BP/ST/AS/EC/** version)	[kg]	195	305	305	415	425	445

DIMENSIONS - Large unit							
Lenght	[mm]	1730	1980	1980	2330	2330	2330
Width	[mm]	685	835	835	1025	1025	1025
Height (ST - LN)	[mm]	1405	1820	1820	2221	2221	2221
Height (SL)	[mm]	-	-	-	2308	2308	2308

Unit dimensions with hydronic kit							
Integrata LP 1-0 OO	-	Standard	Standard	Standard	Standard	Standard	Standard
Integrata LP 1-0 OO and HR equipment	-	Large	Large	Large	Large	Large	Large
Integrata LP 1-1 OO	-	Large	Large	Large	Large	Large	Large
Integrata LP 1-1 OO and HR equipment	-	Large	Large	Large	Large	Large	Large
Integrata MP 1-0 OO	-	Standard	Standard	Standard	Standard	Standard	Standard
Integrata MP 1-0 OO and HR equipment	-	Large	Large	Large	Large	Large	Large
Integrata MP 1-1 OO	-	Large	Large	Large	Large	Large	Large
Integrata MP 1-1 OO and HR equipment	-	Large	Large	Large	Large	Large	Large
Base-P LP 1-0 OO	-	Standard	Standard	Standard	Standard	Standard	Standard
Base-P LP 1-0 OO and HR equipment	-	Large	Standard	Standard	Standard	Standard	Standard
Base-P LP 1-1 OO	-	Standard	Standard	Standard	Standard	Standard	Standard
Base-P LP 1-1 OO and HR equipment	-	Large	Large	Large	Standard	Standard	Standard
Base-P MP 1-0 OO	-	Standard	Standard	Standard	Standard	Standard	Standard
Base-P MP 1-0 OO and HR equipment	-	Large	Standard	Standard	Standard	Standard	Standard
Base-P MP 1-1 OO	-	Standard	Standard	Standard	Standard	Standard	Standard
Base-P MP 1-1 OO and HR equipment	-	Large	Large	Large	Standard	Standard	Standard
Base-T	-	Standard	Standard	Standard	Standard	Standard	Standard
Base-T and HR equipment	-	Large	Large	Large	Large	Large	Large

CRIO BS R290 range		28-1-1 PE	33-1-1 PE	39-1-1 PE	48-1-1 PE	55-1-1 PE	38-2-2 PE
DIMENSIONS AND WEIGHTS - Standard unit							
Lenght	[mm]	1680	2330	2330	2980	2980	2330
Width	[mm]	1025	1025	1025	1025	1025	1025
Height (ST - LN)	[mm]	2121	2221	2221	2300	2300	2221
Height (SL)	[mm]	2208	2308	2308	2360	2360	2308
Shipping weight (A BP/ST/AS/EC/** version)	[kg]	510	660	630	830	840	700
Operating weight (A BP/ST/AS/EC/** version)	[kg]	515	665	635	837	847	705

DIMENSIONS - Large unit							
Lenght	[mm]	2330	2980	2980	3920	3920	2980
Width	[mm]	1025	1025	1025	1025	1025	1025
Height (ST - LN)	[mm]	2221	2221	2221	2360	2360	2221
Height (SL)	[mm]	2308	2308	2308	2420	2420	2308

Unit dimensions with hydronic kit							
Integrata LP 1-0 OO	-	Standard	Standard	Standard	Standard	Standard	Standard
Integrata LP 1-0 OO and HR equipment	-	Large	Large	Large	Standard	Standard	Large
Integrata LP 1-1 OO	-	Large	Standard	Standard	Standard	Standard	Standard
Integrata LP 1-1 OO and HR equipment	-	Large	Large	Large	Large	Large	Large
Integrata MP 1-0 OO	-	Standard	Standard	Standard	Standard	Standard	Standard
Integrata MP 1-0 OO and HR equipment	-	Large	Large	Large	Standard	Standard	Large
Integrata MP 1-1 OO	-	Large	Standard	Standard	Standard	Standard	Standard
Integrata MP 1-1 OO and HR equipment	-	Large	Large	Large	Large	Large	Large
Base-P LP 1-0 OO	-	Standard	Standard	Standard	Standard	Standard	Standard
Base-P LP 1-0 OO and HR equipment	-	Standard	Standard	Standard	Standard	Standard	Standard
Base-P LP 1-1 OO	-	Standard	Standard	Standard	Standard	Standard	Standard
Base-P LP 1-1 OO and HR equipment	-	Standard	Standard	Standard	Standard	Standard	Standard
Base-P MP 1-0 OO	-	Standard	Standard	Standard	Standard	Standard	Standard
Base-P MP 1-0 OO and HR equipment	-	Standard	Standard	Standard	Standard	Standard	Standard
Base-P MP 1-1 OO	-	Standard	Standard	Standard	Standard	Standard	Standard
Base-P MP 1-1 OO and HR equipment	-	Standard	Standard	Standard	Standard	Standard	Standard
Base-T	-	Standard	Standard	Standard	Standard	Standard	Standard
Base-T and HR equipment	-	Large	Standard	Standard	Standard	Standard	Standard

CRIO BS

Dimensions and weights

CRIO BS R290 range		49-2-2 PE	58-2-2 PE	68-2-2 PE	79-2-2 PE	95-2-2 PE	108-2-2 PE
DIMENSIONS AND WEIGHTS - Standard unit							
Lenght	[mm]	2980	2980	2980	3920	3920	3920
Width	[mm]	1025	1025	1025	1025	1025	1025
Height (ST - LN)	[mm]	2300	2300	2300	2360	2360	2360
Height (SL)	[mm]	2360	2360	2360	2420	2420	2420
Shipping weight (A BP/ST/AS/EC/** version)	[kg]	940	970	1000	1200	1260	1280
Operating weight (A BP/ST/AS/EC/** version)	[kg]	947	977	1007	1208	1268	1288

DIMENSIONS - Large unit							
Lenght	[mm]	3920	3920	3920	-	-	-
Width	[mm]	1025	1025	1025	-	-	-
Height (ST - LN)	[mm]	2360	2360	2360	-	-	-
Height (SL)	[mm]	2420	2420	2420	-	-	-

Unit dimensions with hydronic kit							
Integrata LP 1-0 OO	-	Standard	Standard	Standard	Standard	Standard	Standard
Integrata LP 1-0 OO and HR equipment	-	Standard	Standard	Standard	Standard	Standard	Standard
Integrata LP 1-1 OO	-	Standard	Standard	Standard	Standard	Standard	Standard
Integrata LP 1-1 OO and HR equipment	-	Large	Large	Large	Standard	Standard	Standard
Integrata MP 1-0 OO	-	Standard	Standard	Standard	Standard	Standard	Standard
Integrata MP 1-0 OO and HR equipment	-	Standard	Standard	Standard	Standard	Standard	Standard
Integrata MP 1-1 OO	-	Standard	Standard	Standard	Standard	Standard	Standard
Integrata MP 1-1 OO and HR equipment	-	Large	Large	Large	Standard	Standard	Standard
Base-P LP 1-0 OO	-	Standard	Standard	Standard	Standard	Standard	Standard
Base-P LP 1-0 OO and HR equipment	-	Standard	Standard	Standard	Standard	Standard	Standard
Base-P LP 1-1 OO	-	Standard	Standard	Standard	Standard	Standard	Standard
Base-P LP 1-1 OO and HR equipment	-	Standard	Standard	Standard	Standard	Standard	Standard
Base-P MP 1-0 OO	-	Standard	Standard	Standard	Standard	Standard	Standard
Base-P MP 1-0 OO and HR equipment	-	Standard	Standard	Standard	Standard	Standard	Standard
Base-P MP 1-1 OO	-	Standard	Standard	Standard	Standard	Standard	Standard
Base-P MP 1-1 OO and HR equipment	-	Standard	Standard	Standard	Standard	Standard	Standard
Base-T	-	Standard	Standard	Standard	Standard	Standard	Standard
Base-T and HR equipment	-	Standard	Standard	Standard	Standard	Standard	Standard

CRIO BS R290 range		126-2-2 PE	137-2-2 PE	157-2-2 PE	173-2-2 PE	158-2-2 PV	174 & 182-2-2 PV
DIMENSIONS AND WEIGHTS - Standard unit							
Lenght	[mm]	4200	4200	5500	5500	2895	2895
Width	[mm]	1185	1185	1535	1535	2280	2280
Height (ST - LN)	[mm]	2320	2320	2350	2350	2535	2535
Height (SL)	[mm]	2380	2380	2410	2410	2560	2560
Shipping weight (A BP/ST/AS/EC/** version)	[kg]	1630	1670	1700	1920	1925	1940
Operating weight (A BP/ST/AS/EC/** version)	[kg]	1640	1680	1710	1930	1940	1955

DIMENSIONS - Large unit							
Lenght	[mm]	5000	5000	Contact EK	Contact EK	4015	4015
Width	[mm]	1185	1185	Contact EK	Contact EK	2280	2280
Height (ST - LN)	[mm]	2320	2320	Contact EK	Contact EK	2535	2535
Height (SL)	[mm]	2380	2380	Contact EK	Contact EK	2560	2560

Unit dimensions with hydronic kit							
Integrata LP 1-0 OO	-	Large	Large	Standard	Standard	Standard	Standard
Integrata LP 1-0 OO and HR equipment	-	Large	Large	Contact EK	Contact EK	Large	Large
Integrata LP 1-1 OO	-	Large	Large	Standard	Standard	Large	Large
Integrata LP 1-1 OO and HR equipment	-	Large	Large	Contact EK	Contact EK	Large	Large
Integrata MP 1-0 OO	-	Large	Large	Standard	Standard	Standard	Standard
Integrata MP 1-0 OO and HR equipment	-	Large	Large	Contact EK	Contact EK	Large	Large
Integrata MP 1-1 OO	-	Large	Large	Standard	Standard	Large	Large
Integrata MP 1-1 OO and HR equipment	-	Large	Large	Contact EK	Contact EK	Large	Large
Base-P LP 1-0 OO	-	Standard	Standard	Standard	Standard	Standard	Standard
Base-P LP 1-0 OO and HR equipment	-	Standard	Standard	Standard	Standard	Standard	Standard
Base-P LP 1-1 OO	-	Standard	Standard	Standard	Standard	Standard	Standard
Base-P LP 1-1 OO and HR equipment	-	Standard	Standard	Standard	Standard	Standard	Standard
Base-P MP 1-0 OO	-	Standard	Standard	Standard	Standard	Standard	Standard
Base-P MP 1-0 OO and HR equipment	-	Standard	Standard	Standard	Standard	Standard	Standard
Base-P MP 1-1 OO	-	Standard	Standard	Standard	Standard	Standard	Standard
Base-P MP 1-1 OO and HR equipment	-	Standard	Standard	Standard	Standard	Standard	Standard
Base-T	-	Standard	Standard	Standard	Standard	Standard	Standard
Base-T and HR equipment	-	Large	Large	Contact EK	Contact EK	Large	Large

CRIO HE

10-1-1 PE ↔ 116-2-2 PE



Refrigerant
R290 | GWP=3



Brazed plate
heat exchanger



Semi-hermetic
piston compressor



Axial fan



Cu/Al
condensing coils



Air to water chillers for medium temperature applications
High efficiency



Solution

B - Base
I - Integrata

Version

ST - Standard
LN - Low Noise
SL - Super Low Noise

Equipment

AS - Standard equipment
DS - Desuperheater
HR - Total modulating Heat Recovery

Cooling capacity 9 - 112 kW

Safety system

To ensure high-safety-level the unit is equipped with an **ATEX certified gas detector** and an **EC centrifugal extraction fan**. The sensor, with external dedicated power supply and Modbus output signal, has an alarm threshold set at 10% of the lower flammable limit (LFL). The Propane alarm causes the immediate shutdown of the machine and the centrifugal extraction fan is switched on, which allows the ventilation of the compressor compartment and the dilution of the R290 concentration to values below the lower flammability limit.

Structure

Structure specifically designed and built to guarantee total resistance to atmospheric agents and corrosion. Basement and panels made of galvanized steel sheet, oven-painted with polyurethane powders. Frame made of anodized aluminium profiles, with aluminium alloy corner joints that guarantee excellent mechanical resistance and low weight. LN (Low Noise) version: the panels are internally lined with sound-absorbing material. SL (Super Low Noise) version: the panels are sandwich and insulated with rock wool.

Compressor

Reciprocating semi-hermetic type compressor equipped with: electronic control module and protection of the electric motor (installed inside the electrical panel); oil charge; oil level sight glass and oil crankcase heater; anti-vibration rubber supports; anti-vibration pipes (suction and discharge); suction and discharge valves. The compressor can be supplied with one or more RSH capacity control heads to guarantee an adaptation of the cooling capacity in case of thermal load's reduction: please see the list of accessories for further information.

EC Fan

Premium-Axial-Fans with bionic shaped blades and high-efficient EC (Electronically Commutated) external rotor motors, sealed in protection IP54 and thermal class THCL 155. The motor efficiency class complies with IE4.

Air heat exchanger

Finned coil made with copper pipes arranged on staggered rows, mechanically expanded inside a pack of aluminium fins offering a high exchange surface area.

Water heat exchanger

Brazed plate-type heat exchanger, stainless steel AISI 316 made, complete with water differential pressure switch, air vent valve and thermally insulated with closed-cell neoprene anti-condensate material. The heat exchanger design provides high thermal exchange and high performance results, furthermore it guarantees small dimensions and easy installation and maintenance.

Electrical board

Each unit is equipped with electric panel, built, wired and fully tested at the factory. Wiring numeration and optimized layout facilitate troubleshooting. The installed components are identified by nameplates to better identify the application and the type of action. Switchboard is made according to standards IEC 204-1/EN60204-1 and it is complete with the following main components: - Main isolator switch - Door interlock safety device - Contactor and protection for compressor and fans - Cabinet minimum protection rating IP54.

To ensure higher level of security, the cabinet is outside the machine and positioned on one side of the unit. The propane sensor is equipped with separate power supply: this power supply must always be guaranteed in order to ensure the monitoring of any leakage.

Control

The microprocessor controls the unit capacity by timing the compressors and checks the operating alarms with the possibility to connect to BMS.

Refrigerant circuit

Filter drier, moisture-liquid sight glass, electronic expansion valve, high & low pressure gauge, high and low pressure transducers, high pressure switch, safety high pressure valve (when required by EN 378-2016 standard).

Water circuit

(Integrata)

Base version: as interface to the plant, includes the water fittings of the evaporator only.

Integrated version: Water storage tank, water pressure gauge, safety valve, water discharge valve, centrifugal pump(s) suitable for glycol solutions up to 40%, manual by-pass valve, manual air venting valve. The pump control equipment is fitted inside the electrical board of the unit and the microprocessor control manages the pump starting, timing and all the safety devices of the whole system.

ACCESSORI PRINCIPALI

- Anti-vibration rubber/spring mounts
- Air heat exchanger protection panel or filter
- Air heat exchanger with various coatings treatment
- Low pressure switch
- Low pressure safety valve
- Double safety valve
- Overpressure valve / automatic by-pass
- Double water pump (stand-by) - Standard/ High pressure
- Open / Closed expansion vessel with automatic filling unit
- RSH Capacity Control head / Inverter driven compressor
- Advanced control c.pCo

CRIO HE

Technical data

CRIO HE R290 range		10-1-1 PE	14-1-1 PE	17-1-1 PE	20-1-1 PE	24-1-1 PE	30-1-1 PE
COOLING - A BP/ST/AS/EC/*S version							
Cooling capacity ⁽¹⁾	[kW]	8,46	11,7	16,7	19,9	21,3	27,2
Total power input ⁽¹⁾	[kW]	3,98	5,94	7,88	9,81	10,0	12,6
EER - Energy Efficiency Ratio	-	2,13	1,97	2,12	2,03	2,13	2,16
Saved CO2 equivalent Ton (*)	[CO ₂ Ton]	8,3	10,7	11,5	15,5	15,5	20,4
"Ecodesign" compliance for process application (SEPR)	-	3,58	3,25	3,79	3,82	3,47	3,70

REFRIGERANT CIRCUIT								
Refrigerant	-	R290						
GWP	-	3						
Charge of refrigerant - Base unit	[kg]	2,2	2,8	3,0	4,0	4,0	5,3	
Independent gas circuits	[n°]	1						
Compressors type	-	Semi-hermetic pistons						
Compressors quantity	[n°]	1						
Steps of capacity for each compressor (std)	-	1 (75%); 2 (50%)						
Condensing coils type	-	Cu/Al						
Fans type	-	Axial EC						
Fans quantity	[n°]	1			2			
Fans power input ⁽¹⁾ (total)	[kW]	0,07	0,14	0,59	1,08	0,51	0,58	
Total air flow	[m ³ /h]	5.100	6.100	10.300	19.700	15.000	18.400	
Expansion valve type	-	Electronic						
Evaporator water flow ⁽¹⁾	[m ³ /h]	2,08	2,88	4,09	4,89	5,23	6,67	
User circuit pressure drop ⁽¹⁾	[kPa]	21,1	22,5	28,4	28,7	24,8	30,2	

DESUPERHEATER (option) - A BP/ST/DS/EC/*S							
Heating capacity ⁽²⁾	[kW]	1,84	2,73	3,21	3,75	4,13	5,03
Water flow	[m ³ /h]	0,32	0,47	0,56	0,65	0,72	0,87
User circuit pressure drop	[kPa]	2,3	2,9	2,6	2,5	2,3	2,6

HEAT RECOVERY (option) - A BP/ST/HR/EC/*S							
Heating capacity ⁽²⁾	[kW]	12,3	17,5	23,9	28,5	30,3	38,9
Water flow	[m ³ /h]	2,13	3,02	4,13	4,94	5,26	6,73
User circuit pressure drop	[kPa]	13,7	24	26,7	26,6	23,2	29,5

Electrical data							
Power supply	-	400/3/50					
Emergency power supply	-	230/1/50					
Maximum power input without pump	[kW]	9,30	13,1	14,1	17,7	20,2	22,5
Locked rotor current - LRA without pump	[A]	65,0	89,2	104	121	140	207
Maximum absorbed current - FLA without pump	[A]	15,7	22,5	23,5	32,5	39,7	40,7

HYDRONIC KIT (option)							
Buffer tank capacity	[L]	60	60	60	160	160	290
Pump type	-	Centrifugal					

Standard pump - 150 kPa useful head							
Motor Efficiency	-	-	-	-	-	-	IE3
Pump motor nominal power	[kW]	0,37	0,37	0,55	0,55	0,55	0,9
Pump motor nominal current	[A]	1,4	1,4	1,9	1,9	1,9	2,5

Standard pump - 250 kPa useful head							
Motor Efficiency	-	-	IE3	IE3	IE3	IE3	IE3
Pump motor nominal power	[kW]	0,55	0,75	0,9	0,9	1,5	1,5
Pump motor nominal current	[A]	2	1,9	2,5	2,5	4,1	4,1

Water connections							
Dimension (nominal external diameter)	[inch/DN]	1/2" (DN15)	1" (DN 25)	1" (DN 25)	1" (DN 25)	1" (DN 25)	1" 1/2 (DN 40)

Noise levels ⁽³⁾							
Total sound power (ST version)	[db(A)]	73	76	79	82	82	81
Total sound pressure (ST version) - at 1 m distance	[db(A)]	56	59	62	65	65	63
Total sound pressure (ST version) - at 10 m distance	[db(A)]	43	45	48	51	51	50
Total sound power (LN version)	[db(A)]	70	73	76	79	79	78
Total sound pressure (LN version) - at 1 m distance	[db(A)]	53	56	59	62	62	60
Total sound pressure (LN version) - at 10 m distance	[db(A)]	40	42	45	48	48	47
Total sound power (SL version)	[db(A)]	68	71	74	77	77	76
Total sound pressure (SL version) - at 1 m distance	[db(A)]	51	54	57	60	60	58
Total sound pressure (SL version) - at 10 m distance	[db(A)]	38	40	43	46	46	45

Reference conditions:

(1) Condenser air intake temperature = 35 °C - Evaporator fluid temperature IN/OUT = -4/-8 °C; Fluid: MEG 35% - Condensing coil: Cu/Al or microchannel according to models. Results according to UNI EN 14511-2022.

(2) Condenser air intake temperature = 35 °C - Evaporator fluid temperature IN/OUT = -4/-8 °C; Fluid: MEG 35% - Recovery user temp. IN/OUT = 40/45 °C; Fluid: water - Condensing coil: Cu/Al or microchannel according to models. Result: according to UNI EN 14511-2022.

(3) Sound power level in compliance with ISO 3744 - Sound pressure level (average) at 10 meter distance, unit in a free field on a reflective surface; non-binding value obtained from the sound power level.

(*) CO2 equivalent tons saved to the Environment compared to the choice of an EUOKLIMAT unit with similar cooling capacity and HFC refrigerant

CRIO HE

Technical data

CRIO HE R290 range		35-1-1 PE	41-1-1 PE	48-1-1 PE	56-1-1 PE	41-2-2 PE	48-2-2 PE
COOLING - A BP/ST/AS/EC/*S version							
Cooling capacity ⁽¹⁾	[kW]	31,8	39,2	47,1	55,0	40,0	42,5
Total power input ⁽¹⁾	[kW]	15,8	19,7	23,6	26,5	18,5	19,6
EER - Energy Efficiency Ratio	-	2,01	1,99	2,00	2,08	2,16	2,17
Saved CO2 equivalent Ton (*)	[CO ₂ Ton]	23,5	24,5	29,4	39,0	32,9	39,4
"Ecodesign" compliance for process application (SEPR)	-	3,25	3,26	3,61	3,75	3,93	3,49

REFRIGERANT CIRCUIT							
Refrigerant	-	R290					
GWP	-	3					
Charge of refrigerant - Base unit	[kg]	6,1	6,3	7,6	10,1	8,5	10,2
Independent gas circuits	[n°]	1			2		
Compressors type	-	Semi-hermetic pistons					
Compressors quantity	[n°]	1			2		
Steps of capacity for each compressor (std)	-	1 (75%); 2 (50%)	1 (83%); 2 (67%); 3 (50%)			1 (75%); 2 (50%)	
Condensing coils type	-	Cu/Al					
Fans type	-	Axial EC					
Fans quantity	[n°]	2			3		
Fans power input ⁽¹⁾ (total)	[kW]	1,23	2,83	3,35	2,06	1,11	0,65
Total air flow	[m ³ /h]	24.000	35.000	34.200	34.400	29.400	22.600
Expansion valve type	-	Electronic					
Evaporator water flow ⁽¹⁾	[m ³ /h]	7,78	9,59	11,5	13,5	9,80	10,4
User circuit pressure drop ⁽¹⁾	[kPa]	17,4	20,0	26,8	29,0	22,3	23,4

DESUPERHEATER (option) - A BP/ST/DS/EC/*S							
Heating capacity ⁽²⁾	[kW]	6,24	7,01	8,31	10,4	7,50	8,26
Water flow	[m ³ /h]	1,08	1,22	1,44	1,80	1,30	1,43
User circuit pressure drop	[kPa]	3,1	2,7	2,5	2,8	4,2	5,0

HEAT RECOVERY (option) - A BP/ST/HR/EC/*S							
Heating capacity ⁽²⁾	[kW]	45,6	55,1	67,4	79,4	57,3	60,4
Water flow	[m ³ /h]	7,90	9,54	11,7	13,8	9,93	10,5
User circuit pressure drop	[kPa]	33,6	41,4	29,2	30,3	23,3	24,8

Electrical data							
Power supply	-	400/3/50					
Emergency power supply	-	230/1/50					
Maximum power input without pump	[kW]	27,5	37,8	42,6	47,7	34,3	39,3
Locked rotor current - LRA without pump	[A]	228	249	282	327	152	178
Maximum absorbed current - FLA without pump	[A]	47,8	63,2	70,3	80,3	63,1	77,5

HYDRONIC KIT (option)							
Buffer tank capacity	[L]	290	290	290	290	290	290
Pump type	-	Centrifugal					

Standard pump - 150 kPa useful head							
Motor Efficiency	-	IE3					
Pump motor nominal power	[kW]	0,9	0,9	1,1	1,1	1,1	1,1
Pump motor nominal current	[A]	2,5	2,5	3,3	3,3	3,3	3,3

Standard pump - 250 kPa useful head							
Motor Efficiency	-	IE3					
Pump motor nominal power	[kW]	1,5	1,5	2,2	2,2	1,5	2,2
Pump motor nominal current	[A]	4,1	4,1	4,7	4,7	4,1	4,7

Water connections							
Dimension (nominal external diameter)	[inch/DN]	1" 1/2 (DN 40)	1" 1/2 (DN 40)	1" 1/2 (DN 40)	2" (DN 50)	1" 1/2 (DN 40)	1" 1/2 (DN 40)

Noise levels ⁽³⁾							
Total sound power (ST version)	[dB(A)]	84	86	87	86	83	84
Total sound pressure (ST version) - at 1 m distance	[dB(A)]	66	68	69	68	65	66
Total sound pressure (ST version) - at 10 m distance	[dB(A)]	53	55	56	54	51	52
Total sound power (LN version)	[dB(A)]	81	83	84	83	80	81
Total sound pressure (LN version) - at 1 m distance	[dB(A)]	63	65	66	65	62	63
Total sound pressure (LN version) - at 10 m distance	[dB(A)]	50	52	53	51	48	49
Total sound power (SL version)	[dB(A)]	79	81	82	81	78	79
Total sound pressure (SL version) - at 1 m distance	[dB(A)]	61	63	64	63	60	61
Total sound pressure (SL version) - at 10 m distance	[dB(A)]	48	50	51	49	46	47

Reference conditions:

(1) Condenser air intake temperature = 35 °C - Evaporator fluid temperature IN/OUT = -4/-8 °C; Fluid: MEG 35% - Condensing coil: Cu/Al or microchannel according to models. Results according to UNI EN 14511-2022.

(2) Condenser air intake temperature = 35 °C - Evaporator fluid temperature IN/OUT = -4/-8 °C; Fluid: MEG 35% - Recovery user temp. IN/OUT = 40/45 °C; Fluid: water - Condensing coil: Cu/Al or microchannel according to models. Result: according to UNI EN 14511-2022.

(3) Sound power level in compliance with ISO 3744 - Sound pressure level (average) at 10 meter distance, unit in a free field on a reflective surface; non-binding value obtained from the sound power level.

(*) CO2 equivalent tons saved to the Environment compared to the choice of an EUROLIMAT unit with similar cooling capacity and HFC refrigerant

CRIO HE

Technical data

CRIO HE R290 range		60-2-2 PE	70-2-2 PE	83-2-2 PE	97-2-2 PE	116-2-2 PE
COOLING - A BP/ST/AS/EC/*S version						
Cooling capacity ⁽¹⁾	[kW]	54,9	63,7	78,5	95,3	112
Total power input ⁽¹⁾	[kW]	26,1	32,5	36,4	46,9	51,9
EER - Energy Efficiency Ratio	-	2,10	1,96	2,16	2,03	2,16
Saved CO2 equivalent Ton (*)	[CO ₂ Ton]	41,6	45,2	65,5	67,5	87,6
"Ecodesign" compliance for process application (SEPR)	-	3,62	3,18	3,60	3,63	3,89

REFRIGERANT CIRCUIT						
Refrigerant	-	R290				
GWP	-	3				
Charge of refrigerant - Base unit	[kg]	10,8	11,7	17,0	17,5	22,8
Independent gas circuits	[n°]	2				
Compressors type	-	Semi-hermetic pistons				
Compressors quantity	[n°]	2				
Steps of capacity for each compressor (std)	-	1 (75%); 2 (50%)		1 (83%); 2 (67%); 3 (50%)		
Condensing coils type	-	Cu/Al				
Fans type	-	Axial EC				
Fans quantity	[n°]	3			4	
Fans power input ⁽¹⁾ (total)	[kW]	2,08	3,34	2,57	5,84	2,73
Total air flow	[m ³ /h]	34.400	42.700	51.000	68.300	60.700
Expansion valve type	-	Electronic				
Evaporator water flow ⁽¹⁾	[m ³ /h]	13,5	15,6	19,2	23,4	27,3
User circuit pressure drop ⁽¹⁾	[kPa]	25,1	25,6	29,4	34,3	38,2

DESUPERHEATER (option) - A BP/ST/DS/EC/*S						
Heating capacity ⁽²⁾	[kW]	10,1	12,5	14,0	16,7	20,8
Water flow	[m ³ /h]	1,75	2,17	2,43	2,90	3,61
User circuit pressure drop	[kPa]	5,5	6,5	4,7	4,6	4,8

HEAT RECOVERY (option) - A BP/ST/HR/EC/*S						
Heating capacity ⁽²⁾	[kW]	78,0	91,6	111	136	160
Water flow	[m ³ /h]	13,5	15,9	19,2	23,5	27,7
User circuit pressure drop	[kPa]	37,1	32,2	31,2	31,6	39,3

Electrical data						
Power supply	-	400/3/50				
Emergency power supply	-	230/1/50				
Maximum power input without pump	[kW]	43,9	59,4	72,6	82,2	101
Locked rotor current – LRA without pump	[A]	245	282	307	348	415
Maximum absorbed current - FLA without pump	[A]	79,5	102	122	136	168

HYDRONIC KIT (option)						
Buffer tank capacity	[L]	290	290	500	500	470
Pump type	-	Centrifugal				

Standard pump - 150 kPa useful head						
Motor Efficiency	-	IE3				
Pump motor nominal power	[kW]	1,1	2,2	2,2	2,2	2,2
Pump motor nominal current	[A]	3,3	4,7	4,7	4,7	4,7

Standard pump - 250 kPa useful head						
Motor Efficiency	-	IE3				
Pump motor nominal power	[kW]	2,2	3	3	4	4
Pump motor nominal current	[A]	4,7	6,4	6,4	8,7	8,7

Water connections						
Dimension (nominal external diameter)	[inch/DN]	2" (DN 50)	2" (DN 50)	2" (DN 50)	2"1/2 (DN 65)	2"1/2 (DN 65)

Noise levels ⁽³⁾						
Total sound power (ST version)	[db(A)]	85	88	88	90	89
Total sound pressure (ST version) - at 1 m distance	[db(A)]	67	70	69	71	70
Total sound pressure (ST version) - at 10 m distance	[db(A)]	53	56	56	58	57
Total sound power (LN version)	[db(A)]	82	85	85	87	86
Total sound pressure (LN version) - at 1 m distance	[db(A)]	64	67	66	68	67
Total sound pressure (LN version) - at 10 m distance	[db(A)]	50	53	53	55	54
Total sound power (SL version)	[db(A)]	80	83	83	85	84
Total sound pressure (SL version) - at 1 m distance	[db(A)]	62	65	64	66	65
Total sound pressure (SL version) - at 10 m distance	[db(A)]	48	51	51	53	52

Reference conditions:

(1) Condenser air intake temperature = 35 °C - Evaporator fluid temperature IN/OUT = -4/-8 °C; Fluid: MEG 35% - Condensing coil: Cu/Al or microchannel according to models. Results according to UNI EN 14511-2022.

(2) Condenser air intake temperature = 35 °C - Evaporator fluid temperature IN/OUT = -4/-8 °C; Fluid: MEG 35% - Recovery user temp. IN/OUT = 40/45 °C; Fluid: water - Condensing coil: Cu/Al or microchannel according to models. Result: according to UNI EN 14511-2022.

(3) Sound power level in compliance with ISO 3744 - Sound pressure level (average) at 10 meter distance, unit in a free field on a reflective surface; non-binding value obtained from the sound power level.

(*) CO2 equivalent tons saved to the Environment compared to the choice of an EUROKLIMAT unit with similar cooling capacity and HFC refrigerant

CRIO HE

130-2-2 PV ↔ 185-2-2 PV



Refrigerant
R290 | GWP=3



Braze plate
heat exchanger



Semi-hermetic
piston compressor



Axial fan



Microchannel
condensing coils



Air to water chillers for medium temperature applications
High efficiency



Solution

B - Base
I - Integrata

Version

ST - Standard
LN - Low Noise
SL - Super Low Noise

Equipment

AS - Standard equipment
DS - Desuperheater
HR - Total modulating Heat Recovery

Cooling capacity 124 - 176 kW

Safety system	To ensure high-safety-level the unit is equipped with an ATEX certified gas detector and an EC centrifugal extraction fan . The sensor, with external dedicated power supply and Modbus output signal, has an alarm threshold set at 10% of the lower flammable limit (LFL). The Propane alarm causes the immediate shutdown of the machine and the centrifugal extraction fan is switched on, which allows the ventilation of the compressor compartment and the dilution of the R290 concentration to values below the lower flammability limit.
Structure	Structure specifically designed and built to guarantee total resistance to atmospheric agents and corrosion. Basement and panels made of galvanized steel sheet, oven-painted with polyurethane powders. Frame made of anodized aluminium profiles, with aluminium alloy corner joints that guarantee excellent mechanical resistance and low weight. LN (Low Noise) version: the panels are internally lined with sound-absorbing material. SL (Super Low Noise) version: the panels are sandwich and insulated with rock wool.
Compressor	Reciprocating semi-hermetic type compressor equipped with: electronic control module and protection of the electric motor (installed inside the electrical panel); oil charge; oil level sight glass and oil crankcase heater; anti-vibration rubber supports; anti-vibration pipes (suction and discharge); suction and discharge valves. The compressor can be supplied with one or more RSH capacity control heads to guarantee an adaptation of the cooling capacity in case of thermal load's reduction: please see the list of accessories for further information.
EC Fan	Premium-Axial-Fans with bionic shaped blades and high-efficient EC (Electronically Commutated) external rotor motors, sealed in protection IP54 and thermal class THCL 155. The motor efficiency class complies with IE4.
Air heat exchanger	Microchannel technology increases the primary to secondary surface area ratio and reduces the tube's air shadow to provide maximum heat exchange through our condensers.
Water heat exchanger	Braze plate-type heat exchanger, stainless steel AISI 316 made, complete with water differential pressure switch, air vent valve and thermally insulated with closed-cell neoprene anti-condensate material. The heat exchanger design provides high thermal exchange and high performance results, furthermore it guarantees small dimensions and easy installation and maintenance.
Electrical board	Each unit is equipped with electric panel, built, wired and fully tested at the factory. Wiring numeration and optimized layout facilitate troubleshooting. The installed components are identified by nameplates to better identify the application and the type of action. Switchboard is made according to standards IEC 204-1/EN60204-1 and it is complete with the following main components: - Main isolator switch - Door interlock safety device - Contactor and protection for compressor and fans - Cabinet minimum protection rating IP54. To ensure higher level of security, the cabinet is outside the machine and positioned on one side of the unit. The propane sensor is equipped with separate power supply: this power supply must always be guaranteed in order to ensure the monitoring of any leakage.
Control	The microprocessor controls the unit capacity by timing the compressors and checks the operating alarms with the possibility to connect to BMS.
Refrigerant circuit	Filter drier, moisture-liquid sight glass, electronic expansion valve, high & low pressure gauge, high and low pressure transducers, high pressure switch, safety high pressure valve (when required by EN 378-2016 standard).
Water circuit (Integrata)	Base version: as interface to the plant, includes the water fittings of the evaporator only. Integrated version: Water storage tank, water pressure gauge, safety valve, water discharge valve, centrifugal pump(s) suitable for glycol solutions up to 40%, manual by-pass valve, manual air venting valve. The pump control equipment is fitted inside the electrical board of the unit and the microprocessor control manages the pump starting, timing and all the safety devices of the whole system.

ACCESSORI PRINCIPALI

- Anti-vibration rubber/spring mounts
- Air heat exchanger protection panel or filter
- Air heat exchanger with various coatings treatment
- Low pressure switch
- Low pressure safety valve
- Double safety valve
- Overpressure valve / automatic by-pass
- Double water pump (stand-by) - Standard/ High pressure
- Open / Closed expansion vessel with automatic filling unit
- RSH Capacity Control head / Inverter driven compressor
- Advanced control c.pCo

CRIO HE

Technical data

CRIO HE R290 range		130-2-2 PV	142-2-2 PV	161-2-2 PV	175-2-2 PV	185-2-2 PV
COOLING - A BP/ST/AS/EC/*S version						
Cooling capacity ⁽¹⁾	[kW]	124	136	155	165	176
Total power input ⁽¹⁾	[kW]	58,8	65,2	72,0	76,8	86,9
EER - Energy Efficiency Ratio	-	2,11	2,09	2,15	2,15	2,03
Saved CO2 equivalent Ton ^(*)	[CO ₂ Ton]	55,8	61,1	77,0	77,9	81,4
"Ecodesign" compliance for process application (SEPR)	-	3,68	3,58	3,66	3,78	3,44

REFRIGERANT CIRCUIT						
Refrigerant	-	R290				
GWP	-	3				
Charge of refrigerant - Base unit	[kg]	14,5	15,9	20,0	20,2	21,2
Independent gas circuits	[n°]	2				
Compressors type	-	Semi-hermetic pistons				
Compressors quantity	[n°]	2				
Steps of capacity for each compressor (std)	-	2 (75%); 3 (62,5%); 4 (50%)				
Condensing coils type	-	Microchannel				
Fans type	-	Axial EC				
Fans quantity	[n°]	4		6		
Fans power input ⁽¹⁾ (total)	[kW]	3,41	4,64	2,87	3,63	4,43
Total air flow	[m ³ /h]	66.500	75.000	79.600	87.000	94.500
Expansion valve type	-	Electronic				
Evaporator water flow ⁽¹⁾	[m ³ /h]	30,4	33,3	38,0	40,4	43,0
User circuit pressure drop ⁽¹⁾	[kPa]	40,0	35,2	34,0	37,3	33,8

DESUPERHEATER (option) - A BP/ST/DS/EC/*S						
Heating capacity ⁽²⁾	[kW]	24,0	26,3	31,4	32,8	38,7
Water flow	[m ³ /h]	4,17	4,56	5,44	5,69	6,72
User circuit pressure drop	[kPa]	4,0	4,3	12,1	11,9	14,6

HEAT RECOVERY (option) - A BP/ST/HR/EC/*S						
Heating capacity ⁽²⁾	[kW]	176	192	219	233	253
Water flow	[m ³ /h]	30,5	33,3	38,0	40,3	43,9
User circuit pressure drop	[kPa]	39,6	45,6	50,7	50,5	39,5

Electrical data						
Power supply	-	400/3/50				
Emergency power supply	-	230/1/50				
Maximum power input without pump	[kW]	95,1	114	120	125	133
Locked rotor current – LRA without pump	[A]	390	473	568	670	714
Maximum absorbed current - FLA without pump	[A]	166	193	199	216	232

HYDRONIC KIT (option)						
Buffer tank capacity	[L]	290	290	290	290	290
Pump type	-	Centrifugal				

Standard pump - 150 kPa useful head						
Motor Efficiency	-	IE3				
Pump motor nominal power	[kW]	3	3	3	3	3
Pump motor nominal current	[A]	6,4	6,4	6,4	6,4	6,4

Standard pump - 250 kPa useful head						
Motor Efficiency	-	IE3				
Pump motor nominal power	[kW]	4	4	5,5	5,5	5,5
Pump motor nominal current	[A]	8,7	8,7	10,6	10,6	10,6

Water connections						
Dimension (nominal external diameter)	[inch/DN]	3" (DN 80)	3" (DN 80)	3" (DN 80)	3" (DN 80)	3" (DN 80)

Noise levels ⁽³⁾						
Total sound power (ST version)	[db(A)]	90	94	95	95	97
Total sound pressure (ST version) - at 1 m distance	[db(A)]	71	75	75	75	77
Total sound pressure (ST version) - at 10 m distance	[db(A)]	58	62	63	63	65
Total sound power (LN version)	[db(A)]	87	91	92	92	94
Total sound pressure (LN version) - at 1 m distance	[db(A)]	68	72	72	72	74
Total sound pressure (LN version) - at 10 m distance	[db(A)]	55	59	60	60	62
Total sound power (SL version)	[db(A)]	85	89	90	90	92
Total sound pressure (SL version) - at 1 m distance	[db(A)]	66	70	70	70	72
Total sound pressure (SL version) - at 10 m distance	[db(A)]	53	57	58	58	60

Reference conditions:

(1) Condenser air intake temperature = 35 °C - Evaporator fluid temperature IN/OUT = -4/-8 °C; Fluid: MEG 35% - Condensing coil: Cu/Al or microchannel according to models. Results according to UNI EN 14511-2022.

(2) Condenser air intake temperature = 35 °C - Evaporator fluid temperature IN/OUT = -4/-8 °C; Fluid: MEG 35% - Recovery user temp. IN/OUT = 40/45 °C; Fluid: water - Condensing coil: Cu/Al or microchannel according to models. Result: according to UNI EN 14511-2022.

(3) Sound power level in compliance with ISO 3744 - Sound pressure level (average) at 10 meter distance, unit in a free field on a reflective surface; non-binding value obtained from the sound power level.

(*) CO2 equivalent tons saved to the Environment compared to the choice of an EUROKLIMAT unit with similar cooling capacity and HFC refrigerant

CRIO HE

Dimensions and weights

CRIO HE R290 range		60-2-2 PE	70-2-2 PE	83-2-2 PE	97-2-2 PE	116-2-2 PE	130-2-2 PV
DIMENSIONS AND WEIGHTS - Standard unit							
Lenght	[mm]	3920	3920	4200	4200	5500	2895
Width	[mm]	1025	1025	1185	1185	1535	2280
Height (ST - LN)	[mm]	2281	2360	2320	2320	2350	2535
Height (SL)	[mm]	2368	2420	2380	2380	2410	2560
Shipping weight (A BP/ST/AS/EC/** version)	[kg]	1080	1150	1460	1510	1710	1855
Operating weight (A BP/ST/AS/EC/** version)	[kg]	1088	1158	1470	1520	1720	1870

DIMENSIONS - Large unit							
Lenght	[mm]	-	-	5000	5000	Contact EK	4015
Width	[mm]	-	-	1185	1185	Contact EK	2280
Height (ST - LN)	[mm]	-	-	2320	2320	Contact EK	2535
Height (SL)	[mm]	-	-	2380	2380	Contact EK	2560

Unit dimensions with hydronic kit							
Integrata LP 1-0 OO	-	Standard	Standard	Large	Large	Standard	Standard
Integrata LP 1-0 OO and HR equipment	-	Standard	Standard	Large	Large	Contact EK	Large
Integrata LP 1-1 OO	-	Standard	Standard	Large	Large	Standard	Large
Integrata LP 1-1 OO and HR equipment	-	Standard	Standard	Large	Large	Contact EK	Large
Integrata MP 1-0 OO	-	Standard	Standard	Large	Large	Standard	Standard
Integrata MP 1-0 OO and HR equipment	-	Standard	Standard	Large	Large	Contact EK	Large
Integrata MP 1-1 OO	-	Standard	Standard	Large	Large	Standard	Large
Integrata MP 1-1 OO and HR equipment	-	Standard	Standard	Large	Large	Contact EK	Large
Base-P LP 1-0 OO	-	Standard	Standard	Standard	Standard	Standard	Standard
Base-P LP 1-0 OO and HR equipment	-	Standard	Standard	Standard	Standard	Standard	Standard
Base-P LP 1-1 OO	-	Standard	Standard	Standard	Standard	Standard	Standard
Base-P LP 1-1 OO and HR equipment	-	Standard	Standard	Standard	Standard	Standard	Standard
Base-P MP 1-0 OO	-	Standard	Standard	Standard	Standard	Standard	Standard
Base-P MP 1-0 OO and HR equipment	-	Standard	Standard	Standard	Standard	Standard	Standard
Base-P MP 1-1 OO	-	Standard	Standard	Standard	Standard	Standard	Standard
Base-P MP 1-1 OO and HR equipment	-	Standard	Standard	Standard	Standard	Standard	Standard
Base-T	-	Standard	Standard	Standard	Standard	Standard	Standard
Base-T and HR equipment	-	Standard	Standard	Large	Large	Contact EK	Large

CRIO HE R290 range		142-2-2 PV	161-2-2 PV	175-2-2 PV	185-2-2 PV
DIMENSIONS AND WEIGHTS - Standard unit					
Lenght	[mm]	2895	4015	4015	4015
Width	[mm]	2280	2280	2280	2280
Height (ST - LN)	[mm]	2535	2535	2535	2535
Height (SL)	[mm]	2560	2560	2560	2560
Shipping weight (A BP/ST/AS/EC/** version)	[kg]	1900	2560	2575	2590
Operating weight (A BP/ST/AS/EC/** version)	[kg]	1915	2578	2593	2608

DIMENSIONS - Large unit					
Lenght	[mm]	4015	-	-	-
Width	[mm]	2280	-	-	-
Height (ST - LN)	[mm]	2535	-	-	-
Height (SL)	[mm]	2560	-	-	-

Unit dimensions with hydronic kit					
Integrata LP 1-0 OO	-	Standard	Standard	Standard	Standard
Integrata LP 1-0 OO and HR equipment	-	Large	Standard	Standard	Standard
Integrata LP 1-1 OO	-	Large	Standard	Standard	Standard
Integrata LP 1-1 OO and HR equipment	-	Large	Standard	Standard	Standard
Integrata MP 1-0 OO	-	Standard	Standard	Standard	Standard
Integrata MP 1-0 OO and HR equipment	-	Large	Standard	Standard	Standard
Integrata MP 1-1 OO	-	Large	Standard	Standard	Standard
Integrata MP 1-1 OO and HR equipment	-	Large	Standard	Standard	Standard
Base-P LP 1-0 OO	-	Standard	Standard	Standard	Standard
Base-P LP 1-0 OO and HR equipment	-	Standard	Standard	Standard	Standard
Base-P LP 1-1 OO	-	Standard	Standard	Standard	Standard
Base-P LP 1-1 OO and HR equipment	-	Standard	Standard	Standard	Standard
Base-P MP 1-0 OO	-	Standard	Standard	Standard	Standard
Base-P MP 1-0 OO and HR equipment	-	Standard	Standard	Standard	Standard
Base-P MP 1-1 OO	-	Standard	Standard	Standard	Standard
Base-P MP 1-1 OO and HR equipment	-	Standard	Standard	Standard	Standard
Base-T	-	Standard	Standard	Standard	Standard
Base-T and HR equipment	-	Large	Standard	Standard	Standard

CRIO HE+

10-1-1 PE ↔ 116-2-2 PE

 R290
Refrigerant
R290 | GWP=3

 Brazed plate
heat exchanger

 Semi-hermetic
piston compressor

 Axial fan

 Cu/Al
condensing coils

 EIA ready

 SEPR

Air to water chillers for medium temperature applications
High efficiency plus



Solution

B - Base
I - Integrata

Version

ST - Standard
LN - Low Noise
SL - Super Low Noise

Equipment

AS - Standard equipment
DS - Desuperheater
HR - Total modulating Heat Recovery

Cooling capacity 9 - 112 kW

Safety system	To ensure high-safety-level the unit is equipped with an ATEX certified gas detector and an EC centrifugal extraction fan . The sensor, with external dedicated power supply and Modbus output signal, has an alarm threshold set at 10% of the lower flammable limit (LFL). The Propane alarm causes the immediate shutdown of the machine and the centrifugal extraction fan is switched on, which allows the ventilation of the compressor compartment and the dilution of the R290 concentration to values below the lower flammability limit.
Structure	Structure specifically designed and built to guarantee total resistance to atmospheric agents and corrosion. Basement and panels made of galvanized steel sheet, oven-painted with polyurethane powders. Frame made of anodized aluminium profiles, with aluminium alloy corner joints that guarantee excellent mechanical resistance and low weight. LN (Low Noise) version: the panels are internally lined with sound-absorbing material. SL (Super Low Noise) version: the panels are sandwich and insulated with rock wool.
Compressor	Reciprocating semi-hermetic type compressor equipped with: electronic control module and protection of the electric motor (installed inside the electrical panel); oil charge; oil level sight glass and oil crankcase heater; anti-vibration rubber supports; anti-vibration pipes (suction and discharge); suction and discharge valves. The compressor can be supplied with one or more RSH capacity control heads to guarantee an adaptation of the cooling capacity in case of thermal load's reduction: please see the list of accessories for further information.
EC Fan	Premium-Axial-Fans with bionic shaped blades and high-efficient EC (Electronically Commutated) external rotor motors, sealed in protection IP54 and thermal class THCL 155. The motor efficiency class complies with IE4.
Air heat exchanger	Finned coil made with copper pipes arranged on staggered rows, mechanically expanded inside a pack of aluminium fins offering a high exchange surface area.
Water heat exchanger	Brazed plate-type heat exchanger, stainless steel AISI 316 made, complete with water differential pressure switch, air vent valve and thermally insulated with closed-cell neoprene anti-condensate material. The heat exchanger design provides high thermal exchange and high performance results, furthermore it guarantees small dimensions and easy installation and maintenance.
Electrical board	Each unit is equipped with electric panel, built, wired and fully tested at the factory. Wiring numeration and optimized layout facilitate troubleshooting. The installed components are identified by nameplates to better identify the application and the type of action. Switchboard is made according to standards IEC 204-1/EN60204-1 and it is complete with the following main components: - Main isolator switch - Door interlock safety device - Contactor and protection for compressor and fans - Cabinet minimum protection rating IP54. To ensure higher level of security, the cabinet is outside the machine and positioned on one side of the unit. The propane sensor is equipped with separate power supply: this power supply must always be guaranteed in order to ensure the monitoring of any leakage.
Control	The microprocessor controls the unit capacity by timing the compressors and checks the operating alarms with the possibility to connect to BMS.
Refrigerant circuit	Filter drier, moisture-liquid sight glass, electronic expansion valve, high & low pressure gauge, high and low pressure transducers, high pressure switch, safety high pressure valve (when required by EN 378-2016 standard).
Water circuit (Integrata)	Base version: as interface to the plant, includes the water fittings of the evaporator only. Integrated version: Water storage tank, water pressure gauge, safety valve, water discharge valve, centrifugal pump(s) suitable for glycol solutions up to 40%, manual by-pass valve, manual air venting valve. The pump control equipment is fitted inside the electrical board of the unit and the microprocessor control manages the pump starting, timing and all the safety devices of the whole system.

ACCESSORI PRINCIPALI

- Anti-vibration rubber/spring mounts
- Air heat exchanger protection panel or filter
- Air heat exchanger with various coatings treatment
- Low pressure switch
- Low pressure safety valve
- Double safety valve
- Overpressure valve / automatic by-pass
- Double water pump (stand-by) - Standard/ High pressure
- Open / Closed expansion vessel with automatic filling unit
- RSH Capacity Control head / Inverter driven compressor
- Advanced control c.pCo

CRIO HE+

Technical data

CRIO HE+ R290 range		10-1-1 PE	14-1-1 PE	17-1-1 PE	21-1-1 PE
COOLING - A BP/ST/AS/EC/*S version					
Cooling capacity ⁽¹⁾	[kW]	8,46	11,7	16,7	19,6
Total power input ⁽¹⁾	[kW]	3,98	5,94	7,88	9,03
EER - Energy Efficiency Ratio	-	2,13	1,97	2,12	2,17
Saved CO2 equivalent Ton (*)	[CO ₂ Ton]	8,3	10,7	11,5	15,1
"Ecodesign" compliance for process application (SEPR)	-	3,58	3,25	3,79	3,92

REFRIGERANT CIRCUIT					
Refrigerant	-	R290			
GWP	-	3			
Charge of refrigerant - Base unit	[kg]	2,2	2,8	3,0	3,9
Independent gas circuits	[n°]	1			
Compressors type	-	Semi-hermetic pistons			
Compressors quantity	[n°]	1			
Steps of capacity for each compressor (std)	-	1 (75%); 2 (50%)			
Condensing coils type	-	Cu/Al			
Fans type	-	Axial EC			
Fans quantity	[n°]	1			2
Fans power input ⁽¹⁾ (total)	[kW]	0,07	0,14	0,59	0,36
Total air flow	[m ³ /h]	5.100	6.100	10.300	13.200
Expansion valve type	-	Electronic			
Evaporator water flow ⁽¹⁾	[m ³ /h]	2,08	2,88	4,09	4,82
User circuit pressure drop ⁽¹⁾	[kPa]	21,1	22,5	28,4	27,7

DESUPERHEATER (option) - A BP/ST/DS/EC/*S					
Heating capacity ⁽²⁾	[kW]	1,84	2,73	3,21	3,76
Water flow	[m ³ /h]	0,32	0,47	0,56	0,65
User circuit pressure drop	[kPa]	2,3	2,9	1,9	2,5

HEAT RECOVERY (option) - A BP/ST/HR/EC/*S					
Heating capacity ⁽²⁾	[kW]	12,3	17,5	23,9	28,2
Water flow	[m ³ /h]	2,1	3,0	4,1	4,9
User circuit pressure drop	[kPa]	13,7	24	26,7	26,1

Electrical data					
Power supply	-	400/3/50			
Emergency power supply	-	230/1/50			
Maximum power input without pump	[kW]	9,3	13,1	14,1	17,7
Locked rotor current – LRA without pump	[A]	65,0	89,2	104	121
Maximum absorbed current - FLA without pump	[A]	15,7	22,5	23,5	32,5

HYDRONIC KIT (option)					
Buffer tank capacity	[L]	60	60	60	160
Pump type	-	Centrifugal			

Standard pump - 150 kPa useful head					
Motor Efficiency	-	-	-	-	-
Pump motor nominal power	[kW]	0,37	0,37	0,55	0,55
Pump motor nominal current	[A]	1,4	1,4	1,9	1,9

Standard pump - 250 kPa useful head					
Motor Efficiency	-	-	IE3	IE3	IE3
Pump motor nominal power	[kW]	0,55	0,75	0,9	0,9
Pump motor nominal current	[A]	2	1,9	2,5	2,5

Water connections					
Dimension (nominal external diameter)	[inch/DN]	1/2" (DN15)	1" (DN 25)	1" (DN 25)	1" (DN 25)

Noise levels ⁽³⁾					
Total sound power (ST version)	[db(A)]	73	76	79	80
Total sound pressure (ST version) - at 1 m distance	[db(A)]	56	59	62	63
Total sound pressure (ST version) - at 10 m distance	[db(A)]	43	45	48	49
Total sound power (LN version)	[db(A)]	70	73	76	77
Total sound pressure (LN version) - at 1 m distance	[db(A)]	53	56	59	60
Total sound pressure (LN version) - at 10 m distance	[db(A)]	40	42	45	46
Total sound power (SL version)	[db(A)]	68	71	74	75
Total sound pressure (SL version) - at 1 m distance	[db(A)]	51	54	57	58
Total sound pressure (SL version) - at 10 m distance	[db(A)]	38	40	43	44

Reference conditions:

(1) Condenser air intake temperature = 35 °C - Evaporator fluid temperature IN/OUT = -4/-8 °C; Fluid: MEG 35% - Condensing coil: Cu/Al or microchannel according to models. Results according to UNI EN 14511-2022.

(2) Condenser air intake temperature = 35 °C - Evaporator fluid temperature IN/OUT = -4/-8 °C; Fluid: MEG 35% - Recovery user temp. IN/OUT = 40/45 °C; Fluid: water - Condensing coil: Cu/Al or microchannel according to models. Result: according to UNI EN 14511-2022.

(3) Sound power level in compliance with ISO 3744 - Sound pressure level (average) at 10 meter distance, unit in a free field on a reflective surface; non-binding value obtained from the sound power level.

(*) CO2 equivalent tons saved to the Environment compared to the choice of an EUROLIMAT unit with similar cooling capacity and HFC refrigerant

CRIO HE+

Technical data

CRIO HE+ R290 range		30-1-1 PE	36-1-1 PE	56-1-1 PE	41-2-2 PE
COOLING - A BP/ST/AS/EC/*S version					
Cooling capacity ⁽¹⁾	[kW]	27,2	31,4	55,0	40,0
Total power input ⁽¹⁾	[kW]	12,6	15,1	26,5	18,5
EER - Energy Efficiency Ratio	-	2,16	2,08	2,08	2,16
Saved CO2 equivalent Ton (*)	[CO ₂ Ton]	20,4	27,9	39,0	32,9
"Ecodesign" compliance for process application (SEPR)	-	3,70	3,32	3,75	3,93

REFRIGERANT CIRCUIT					
Refrigerant	-	R290			
GWP	-	3			
Charge of refrigerant - Base unit	[kg]	5,3	7,2	10,1	8,5
Independent gas circuits	[n°]	1			2
Compressors type	-	Semi-hermetic pistons			
Compressors quantity	[n°]	1			2
Steps of capacity for each compressor (std)	-	1 (75%); 2 (50%)		1 (83%); 2 (67%); 3 (50%)	1 (75%); 2 (50%)
Condensing coils type	-	Cu/Al			
Fans type	-	Axial EC			
Fans quantity	[n°]	2		3	
Fans power input ⁽¹⁾ (total)	[kW]	0,58	0,63	2,06	1,11
Total air flow	[m ³ /h]	18.400	17.700	34.400	29.400
Expansion valve type	-	Electronic			
Evaporator water flow ⁽¹⁾	[m ³ /h]	6,67	7,70	13,5	9,80
User circuit pressure drop ⁽¹⁾	[kPa]	30,2	16,9	29,0	22,3

DESUPERHEATER (option) - A BP/ST/DS/EC/*S					
Heating capacity ⁽²⁾	[kW]	5,03	6,25	10,4	7,50
Water flow	[m ³ /h]	0,87	1,09	1,80	1,30
User circuit pressure drop	[kPa]	2,1	3,1	2,4	3,7

HEAT RECOVERY (option) - A BP/ST/HR/EC/*S					
Heating capacity ⁽²⁾	[kW]	38,9	45,3	79,4	57,3
Water flow	[m ³ /h]	6,73	7,84	13,8	9,93
User circuit pressure drop	[kPa]	29,5	33,2	30,3	23,3

Electrical data					
Power supply	-	400/3/50			
Emergency power supply	-	230/1/50			
Maximum power input without pump	[kW]	22,5	27,5	47,7	34,3
Locked rotor current – LRA without pump	[A]	207	228	327	152
Maximum absorbed current - FLA without pump	[A]	40,7	47,8	80,3	63,1

HYDRONIC KIT (option)					
Buffer tank capacity	[L]	290	290	290	290
Pump type	-	Centrifugal			

Standard pump - 150 kPa useful head					
Motor Efficiency	-	IE3			
Pump motor nominal power	[kW]	0,9	0,9	1,1	1,1
Pump motor nominal current	[A]	2,5	2,5	3,3	3,3

Standard pump - 250 kPa useful head					
Motor Efficiency	-	IE3			
Pump motor nominal power	[kW]	1,5	1,5	2,2	1,5
Pump motor nominal current	[A]	4,1	4,1	4,7	4,1

Water connections					
Dimension (nominal external diameter)	[inch/DN]	1" 1/2 (DN 40)	1" 1/2 (DN 40)	2" (DN 50)	1" 1/2 (DN 40)

Noise levels ⁽³⁾					
Total sound power (ST version)	[db(A)]	81	84	86	83
Total sound pressure (ST version) - at 1 m distance	[db(A)]	63	66	68	65
Total sound pressure (ST version) - at 10 m distance	[db(A)]	50	53	54	51
Total sound power (LN version)	[db(A)]	78	81	83	80
Total sound pressure (LN version) - at 1 m distance	[db(A)]	60	63	65	62
Total sound pressure (LN version) - at 10 m distance	[db(A)]	47	50	51	48
Total sound power (SL version)	[db(A)]	76	79	81	78
Total sound pressure (SL version) - at 1 m distance	[db(A)]	58	61	63	60
Total sound pressure (SL version) - at 10 m distance	[db(A)]	45	48	49	46

Reference conditions:

(1) Condenser air intake temperature = 35 °C - Evaporator fluid temperature IN/OUT = -4/-8 °C; Fluid: MEG 35% - Condensing coil: Cu/Al or microchannel according to models. Results according to UNI EN 14511-2022.

(2) Condenser air intake temperature = 35 °C - Evaporator fluid temperature IN/OUT = -4/-8 °C; Fluid: MEG 35% - Recovery user temp. IN/OUT = 40/45 °C; Fluid: water - Condensing coil: Cu/Al or microchannel according to models. Result: according to UNI EN 14511-2022.

(3) Sound power level in compliance with ISO 3744 - Sound pressure level (average) at 10 meter distance, unit in a free field on a reflective surface; non-binding value obtained from the sound power level.

(*) CO2 equivalent tons saved to the Environment compared to the choice of an EUROLIMAT unit with similar cooling capacity and HFC refrigerant

CRIO HE+

Technical data

CRIO HE+ R290 range		48-2-2 PE	83-2-2 PE	99-2-2 PE	116-2-2 PE
COOLING - A BP/ST/AS/EC/*S version					
Cooling capacity ⁽¹⁾	[kW]	42,5	78,5	96,6	112
Total power input ⁽¹⁾	[kW]	19,6	36,4	42,5	51,9
EER - Energy Efficiency Ratio	-	2,17	2,16	2,27	2,16
Saved CO2 equivalent Ton (*)	[CO ₂ Ton]	39,4	65,5	85,8	87,6
"Ecodesign" compliance for process application (SEPR)	-	3,49	3,60	4,05	3,89

REFRIGERANT CIRCUIT					
Refrigerant	-	R290			
GWP	-	3			
Charge of refrigerant - Base unit	[kg]	10,2	17,0	22,3	22,8
Independent gas circuits	[n°]	2			
Compressors type	-	Semi-hermetic pistons			
Compressors quantity	[n°]	2			
Steps of capacity for each compressor (std)	-	1 (75%); 2 (50%)	1 (83%); 2 (67%); 3 (50%)		
Condensing coils type	-	Cu/Al			
Fans type	-	Axial EC			
Fans quantity	[n°]	3		4	
Fans power input ⁽¹⁾ (total)	[kW]	0,65	2,57	1,52	2,73
Total air flow	[m ³ /h]	22.600	51.000	49.000	60.700
Expansion valve type	-	Electronic			
Evaporator water flow ⁽¹⁾	[m ³ /h]	10,4	19,2	23,7	27,3
User circuit pressure drop ⁽¹⁾	[kPa]	23,4	29,4	34,9	38,2

DESUPERHEATER (option) - A BP/ST/DS/EC/*S					
Heating capacity ⁽²⁾	[kW]	8,26	14,0	17,1	20,8
Water flow	[m ³ /h]	1,43	2,43	2,96	3,61
User circuit pressure drop	[kPa]	4,4	4,1	4,5	4,0

HEAT RECOVERY (option) - A BP/ST/HR/EC/*S					
Heating capacity ⁽²⁾	[kW]	60,4	111	137	160
Water flow	[m ³ /h]	10,5	19,2	23,7	27,7
User circuit pressure drop	[kPa]	24,8	31,2	36,6	39,3

Electrical data					
Power supply	-	400/3/50			
Emergency power supply	-	230/1/50			
Maximum power input without pump	[kW]	39,3	72,6	85,3	101
Locked rotor current - LRA without pump	[A]	178	307	353	415
Maximum absorbed current - FLA without pump	[A]	77,5	122	141	168

HYDRONIC KIT (option)					
Buffer tank capacity	[L]	290	500	470	470
Pump type	-	Centrifugal			

Standard pump - 150 kPa useful head					
Motor Efficiency	-	IE3			
Pump motor nominal power	[kW]	1,1	2,2	2,2	2,2
Pump motor nominal current	[A]	3,3	4,7	4,7	4,7

Standard pump - 250 kPa useful head					
Motor Efficiency	-	IE3			
Pump motor nominal power	[kW]	2,2	3	4	4
Pump motor nominal current	[A]	4,7	6,4	8,7	8,7

Water connections					
Dimension (nominal external diameter)	[inch/DN]	1" 1/2 (DN 40)	2" (DN 50)	2"1/2 (DN 65)	2"1/2 (DN 65)

Noise levels ⁽³⁾					
Total sound power (ST version)	[db(A)]	84	88	89	89
Total sound pressure (ST version) - at 1 m distance	[db(A)]	66	69	70	70
Total sound pressure (ST version) - at 10 m distance	[db(A)]	52	56	57	57
Total sound power (LN version)	[db(A)]	81	85	86	86
Total sound pressure (LN version) - at 1 m distance	[db(A)]	63	66	67	67
Total sound pressure (LN version) - at 10 m distance	[db(A)]	49	53	54	54
Total sound power (SL version)	[db(A)]	79	83	84	84
Total sound pressure (SL version) - at 1 m distance	[db(A)]	61	64	65	65
Total sound pressure (SL version) - at 10 m distance	[db(A)]	47	51	52	52

Reference conditions:

(1) Condenser air intake temperature = 35 °C - Evaporator fluid temperature IN/OUT = -4/-8 °C; Fluid: MEG 35% - Condensing coil: Cu/Al or microchannel according to models. Results according to UNI EN 14511-2022.

(2) Condenser air intake temperature = 35 °C - Evaporator fluid temperature IN/OUT = -4/-8 °C; Fluid: MEG 35% - Recovery user temp. IN/OUT = 40/45 °C; Fluid: water - Condensing coil: Cu/Al or microchannel according to models. Result: according to UNI EN 14511-2022.

(3) Sound power level in compliance with ISO 3744 - Sound pressure level (average) at 10 meter distance, unit in a free field on a reflective surface; non-binding value obtained from the sound power level.

(*) CO2 equivalent tons saved to the Environment compared to the choice of an EUROLIMAT unit with similar cooling capacity and HFC refrigerant

CRIO HE+

130-2-2 PV ↔ 185-2-2 PV



Refrigerant
R290 | GWP=3



Brazen plate
heat exchanger



Semi-hermetic
piston compressor



Axial fan



Microchannel
condensing coils



EIA ready



SEPR

Air to water chillers for medium temperature applications
High efficiency plus



Solution

B - Base
I - Integrata

Version

ST - Standard
LN - Low Noise
SL - Super Low Noise

Equipment

AS - Standard equipment
DS - Desuperheater
HR - Total modulating Heat Recovery

Cooling capacity 124 - 176 kW

Safety system	To ensure high-safety-level the unit is equipped with an ATEX certified gas detector and an EC centrifugal extraction fan . The sensor, with external dedicated power supply and Modbus output signal, has an alarm threshold set at 10% of the lower flammable limit (LFL). The Propane alarm causes the immediate shutdown of the machine and the centrifugal extraction fan is switched on, which allows the ventilation of the compressor compartment and the dilution of the R290 concentration to values below the lower flammability limit.
Structure	Structure specifically designed and built to guarantee total resistance to atmospheric agents and corrosion. Basement and panels made of galvanized steel sheet, oven-painted with polyurethane powders. Frame made of anodized aluminium profiles, with aluminium alloy corner joints that guarantee excellent mechanical resistance and low weight. LN (Low Noise) version: the panels are internally lined with sound-absorbing material. SL (Super Low Noise) version: the panels are sandwich and insulated with rock wool.
Compressor	Reciprocating semi-hermetic type compressor equipped with: electronic control module and protection of the electric motor (installed inside the electrical panel); oil charge; oil level sight glass and oil crankcase heater; anti-vibration rubber supports; anti-vibration pipes (suction and discharge); suction and discharge valves. The compressor can be supplied with one or more RSH capacity control heads to guarantee an adaptation of the cooling capacity in case of thermal load's reduction: please see the list of accessories for further information.
EC Fan	Premium-Axial-Fans with bionic shaped blades and high-efficient EC (Electronically Commutated) external rotor motors, sealed in protection IP54 and thermal class THCL 155. The motor efficiency class complies with IE4.
Air heat exchanger	Microchannel technology increases the primary to secondary surface area ratio and reduces the tube's air shadow to provide maximum heat exchange through our condensers.
Water heat exchanger	Brazen plate-type heat exchanger, stainless steel AISI 316 made, complete with water differential pressure switch, air vent valve and thermally insulated with closed-cell neoprene anti-condensate material. The heat exchanger design provides high thermal exchange and high performance results, furthermore it guarantees small dimensions and easy installation and maintenance.
Electrical board	Each unit is equipped with electric panel, built, wired and fully tested at the factory. Wiring numeration and optimized layout facilitate troubleshooting. The installed components are identified by nameplates to better identify the application and the type of action. Switchboard is made according to standards IEC 204-1/EN60204-1 and it is complete with the following main components: - Main isolator switch - Door interlock safety device - Contactor and protection for compressor and fans - Cabinet minimum protection rating IP54. To ensure higher level of security, the cabinet is outside the machine and positioned on one side of the unit. The propane sensor is equipped with separate power supply: this power supply must always be guaranteed in order to ensure the monitoring of any leakage.
Control	The microprocessor controls the unit capacity by timing the compressors and checks the operating alarms with the possibility to connect to BMS.
Refrigerant circuit	Filter drier, moisture-liquid sight glass, electronic expansion valve, high & low pressure gauge, high and low pressure transducers, high pressure switch, safety high pressure valve (when required by EN 378-2016 standard).
Water circuit (Integrata)	Base version: as interface to the plant, includes the water fittings of the evaporator only. Integrated version: Water storage tank, water pressure gauge, safety valve, water discharge valve, centrifugal pump(s) suitable for glycol solutions up to 40%, manual by-pass valve, manual air venting valve. The pump control equipment is fitted inside the electrical board of the unit and the microprocessor control manages the pump starting, timing and all the safety devices of the whole system.

ACCESSORI PRINCIPALI

- Anti-vibration rubber/spring mounts
- Air heat exchanger protection panel or filter
- Air heat exchanger with various coatings treatment
- Low pressure switch
- Low pressure safety valve
- Double safety valve
- Overpressure valve / automatic by-pass
- Double water pump (stand-by) - Standard/ High pressure
- Open / Closed expansion vessel with automatic filling unit
- RSH Capacity Control head / Inverter driven compressor
- Advanced control c.pCo

CRIO HE+

Technical data

CRIO HE+ R290 range		130-2-2 PV	142-2-2 PV	161-2-2 PV	175-2-2 PV	185-2-2 PV
COOLING - A BP/ST/AS/EC/*S version						
Cooling capacity ⁽¹⁾	[kW]	124	136	155	165	176
Total power input ⁽¹⁾	[kW]	58,8	65,2	72,0	76,8	86,9
EER - Energy Efficiency Ratio	-	2,11	2,09	2,15	2,15	2,03
Saved CO2 equivalent Ton (*)	[CO ₂ Ton]	55,8	61,1	77	77,9	81,4
"Ecodesign" compliance for process application (SEPR)	-	3,68	3,58	3,66	3,78	3,44

REFRIGERANT CIRCUIT						
Refrigerant	-	R290				
GWP	-	3				
Charge of refrigerant - Base unit	[kg]	14,5	15,9	20,0	20,2	21,2
Independent gas circuits	[n°]	2				
Compressors type	-	Semi-hermetic pistons				
Compressors quantity	[n°]	2				
Steps of capacity for each compressor (std)	-	2 (75%); 3 (62,5%); 4 (50%)				
Condensing coils type	-	Microchannel				
Fans type	-	Axial EC				
Fans quantity	[n°]	4		6		
Fans power input ⁽¹⁾ (total)	[kW]	3,41	4,64	2,87	3,63	4,43
Total air flow	[m ³ /h]	66.500	75.000	79.600	87.000	94.500
Expansion valve type	-	Electronic				
Evaporator water flow ⁽¹⁾	[m ³ /h]	30,4	33,3	38,0	40,4	43,0
User circuit pressure drop ⁽¹⁾	[kPa]	40,0	35,2	34,0	37,3	33,8

DESUPERHEATER (option) - A BP/ST/DS/EC/*S						
Heating capacity ⁽²⁾	[kW]	24,0	26,3	31,4	32,8	38,7
Water flow	[m ³ /h]	4,17	4,56	5,44	5,69	6,72
User circuit pressure drop	[kPa]	3,5	3,8	11,6	11,4	14,0

HEAT RECOVERY (option) - A BP/ST/HR/EC/*S						
Heating capacity ⁽²⁾	[kW]	176	192	219	233	253
Water flow	[m ³ /h]	30,5	33,3	38,0	40,3	43,9
User circuit pressure drop	[kPa]	39,6	45,6	50,7	50,5	39,5

Electrical data						
Power supply	-	400/3/50				
Emergency power supply	-	230/1/50				
Maximum power input without pump	[kW]	95,1	114	120	125	133
Locked rotor current – LRA without pump	[A]	390	473	568	670	714
Maximum absorbed current - FLA without pump	[A]	166	193	199	216	232

HYDRONIC KIT (option)						
Buffer tank capacity	[L]	290	290	290	290	290
Pump type	-	Centrifugal				

Standard pump - 150 kPa useful head						
Motor Efficiency	-	IE3				
Pump motor nominal power	[kW]	3	3	3	3	3
Pump motor nominal current	[A]	6,4	6,4	6,4	6,4	6,4

Standard pump - 250 kPa useful head						
Motor Efficiency	-	IE3				
Pump motor nominal power	[kW]	4	4	5,5	5,5	5,5
Pump motor nominal current	[A]	8,7	8,7	10,6	10,6	10,6

Water connections						
Dimension (nominal external diameter)	[inch/DN]	3" (DN 80)	3" (DN 80)	3" (DN 80)	3" (DN 80)	3" (DN 80)

Noise levels ⁽³⁾						
Total sound power (ST version)	[db(A)]	90	94	95	95	97
Total sound pressure (ST version) - at 1 m distance	[db(A)]	71	75	75	75	77
Total sound pressure (ST version) - at 10 m distance	[db(A)]	58	62	63	63	65
Total sound power (LN version)	[db(A)]	87	91	92	92	94
Total sound pressure (LN version) - at 1 m distance	[db(A)]	68	72	72	72	74
Total sound pressure (LN version) - at 10 m distance	[db(A)]	55	59	60	60	62
Total sound power (SL version)	[db(A)]	85	89	90	90	92
Total sound pressure (SL version) - at 1 m distance	[db(A)]	66	70	70	70	72
Total sound pressure (SL version) - at 10 m distance	[db(A)]	53	57	58	58	60

Reference conditions:

(1) Condenser air intake temperature = 35 °C - Evaporator fluid temperature IN/OUT = -4/-8 °C; Fluid: MEG 35% - Condensing coil: Cu/Al or microchannel according to models. Results according to UNI EN 14511-2022.

(2) Condenser air intake temperature = 35 °C - Evaporator fluid temperature IN/OUT = -4/-8 °C; Fluid: MEG 35% - Recovery user temp. IN/OUT = 40/45 °C; Fluid: water - Condensing coil: Cu/Al or microchannel according to models. Result: according to UNI EN 14511-2022.

(3) Sound power level in compliance with ISO 3744 - Sound pressure level (average) at 10 meter distance, unit in a free field on a reflective surface; non-binding value obtained from the sound power level.

(*) CO2 equivalent tons saved to the Environment compared to the choice of an EUROKLIMAT unit with similar cooling capacity and HFC refrigerant

CRIO HE+

Dimensions and weights

CRIO HE+ R290 range		10-1-1 PE	14-1-1 PE	17-1-1 PE	21-1-1 PE	30-1-1 PE
DIMENSIONS AND WEIGHTS - Standard unit						
Lenght	[mm]	1680	1680	1680	2330	2980
Width	[mm]	1025	1025	1025	1025	1025
Height (ST - LN)	[mm]	2121	2121	2121	2221	2221
Height (SL)	[mm]	2208	2208	2208	2308	2308
Shipping weight (A BP/ST/AS/EC/** version)	[kg]	350	360	410	560	720
Operating weight (A BP/ST/AS/EC/** version)	[kg]	355	365	415	565	727

DIMENSIONS - Large unit						
Lenght	[mm]	2330	2330	2330	2980	3920
Width	[mm]	1025	1025	1025	1025	1025
Height (ST - LN)	[mm]	2221	2221	2221	2221	2281
Height (SL)	[mm]	2308	2308	2308	2308	2368

Unit dimensions with hydronic kit						
Integrata LP 1-0 OO	-	Standard	Standard	Standard	Standard	Standard
Integrata LP 1-0 OO and HR equipment	-	Large	Large	Large	Large	Standard
Integrata LP 1-1 OO	-	Large	Large	Large	Standard	Standard
Integrata LP 1-1 OO and HR equipment	-	Large	Large	Large	Large	Large
Integrata MP 1-0 OO	-	Standard	Standard	Standard	Standard	Standard
Integrata MP 1-0 OO and HR equipment	-	Large	Large	Large	Large	Standard
Integrata MP 1-1 OO	-	Large	Large	Large	Standard	Standard
Integrata MP 1-1 OO and HR equipment	-	Large	Large	Large	Large	Large
Base-P LP 1-0 OO	-	Standard	Standard	Standard	Standard	Standard
Base-P LP 1-0 OO and HR equipment	-	Standard	Standard	Standard	Standard	Standard
Base-P LP 1-1 OO	-	Standard	Standard	Standard	Standard	Standard
Base-P LP 1-1 OO and HR equipment	-	Standard	Standard	Standard	Standard	Standard
Base-P MP 1-0 OO	-	Standard	Standard	Standard	Standard	Standard
Base-P MP 1-0 OO and HR equipment	-	Standard	Standard	Standard	Standard	Standard
Base-P MP 1-1 OO	-	Standard	Standard	Standard	Standard	Standard
Base-P MP 1-1 OO and HR equipment	-	Standard	Standard	Standard	Standard	Standard
Base-T	-	Standard	Standard	Standard	Standard	Standard
Base-T and HR equipment	-	Large	Large	Large	Standard	Standard

CRIO HE+ R290 range		36-1-1 PE	56-1-1 PE	41-2-2 PE	48-2-2 PE	83-2-2 PE
DIMENSIONS AND WEIGHTS - Standard unit						
Lenght	[mm]	2980	3920	3920	3920	4200
Width	[mm]	1025	1025	1025	1025	1185
Height (ST - LN)	[mm]	2221	2281	2281	2281	2320
Height (SL)	[mm]	2308	2368	2368	2368	2380
Shipping weight (A BP/ST/AS/EC/** version)	[kg]	760	960	940	970	1460
Operating weight (A BP/ST/AS/EC/** version)	[kg]	767	968	948	978	1470

DIMENSIONS - Large unit						
Lenght	[mm]	3920	-	-	-	5000
Width	[mm]	1025	-	-	-	1185
Height (ST - LN)	[mm]	2281	-	-	-	2320
Height (SL)	[mm]	2368	-	-	-	2380

Unit dimensions with hydronic kit						
Integrata LP 1-0 OO	-	Standard	Standard	Standard	Standard	Large
Integrata LP 1-0 OO and HR equipment	-	Standard	Standard	Standard	Standard	Large
Integrata LP 1-1 OO	-	Standard	Standard	Standard	Standard	Large
Integrata LP 1-1 OO and HR equipment	-	Large	Standard	Standard	Standard	Large
Integrata MP 1-0 OO	-	Standard	Standard	Standard	Standard	Large
Integrata MP 1-0 OO and HR equipment	-	Standard	Standard	Standard	Standard	Large
Integrata MP 1-1 OO	-	Standard	Standard	Standard	Standard	Large
Integrata MP 1-1 OO and HR equipment	-	Large	Standard	Standard	Standard	Large
Base-P LP 1-0 OO	-	Standard	Standard	Standard	Standard	Standard
Base-P LP 1-0 OO and HR equipment	-	Standard	Standard	Standard	Standard	Standard
Base-P LP 1-1 OO	-	Standard	Standard	Standard	Standard	Standard
Base-P LP 1-1 OO and HR equipment	-	Standard	Standard	Standard	Standard	Standard
Base-P MP 1-0 OO	-	Standard	Standard	Standard	Standard	Standard
Base-P MP 1-0 OO and HR equipment	-	Standard	Standard	Standard	Standard	Standard
Base-P MP 1-1 OO	-	Standard	Standard	Standard	Standard	Standard
Base-P MP 1-1 OO and HR equipment	-	Standard	Standard	Standard	Standard	Standard
Base-T	-	Standard	Standard	Standard	Standard	Standard
Base-T and HR equipment	-	Standard	Standard	Standard	Standard	Large

CRIO HE+

Dimensions and weights

CRIO HE+ R290 range		99-2-2 PE	116-2-2 PE	130-2-2 PV	142-2-2 PV	161-2-2 PV
DIMENSIONS AND WEIGHTS - Standard unit						
Lenght	[mm]	5500	5500	2895	2895	4015
Width	[mm]	1535	1535	2280	2280	2280
Height (ST - LN)	[mm]	2350	2350	2535	2535	2535
Height (SL)	[mm]	2410	2410	2560	2560	2560
Shipping weight (A BP/ST/AS/EC/** version)	[kg]	1690	1710	1855	1900	2560
Operating weight (A BP/ST/AS/EC/** version)	[kg]	1700	1720	1870	1915	2578

DIMENSIONS - Large unit						
Lenght	[mm]	Contact EK	Contact EK	4015	4015	-
Width	[mm]	Contact EK	Contact EK	2280	2280	-
Height (ST - LN)	[mm]	Contact EK	Contact EK	2535	2535	-
Height (SL)	[mm]	Contact EK	Contact EK	2560	2560	-

Unit dimensions with hydronic kit						
Integrata LP 1-0 OO	-	Standard	Standard	Standard	Standard	Standard
Integrata LP 1-0 OO and HR equipment	-	Contact EK	Contact EK	Large	Large	Standard
Integrata LP 1-1 OO	-	Standard	Standard	Large	Large	Standard
Integrata LP 1-1 OO and HR equipment	-	Contact EK	Contact EK	Large	Large	Standard
Integrata MP 1-0 OO	-	Standard	Standard	Standard	Standard	Standard
Integrata MP 1-0 OO and HR equipment	-	Contact EK	Contact EK	Large	Large	Standard
Integrata MP 1-1 OO	-	Standard	Standard	Large	Large	Standard
Integrata MP 1-1 OO and HR equipment	-	Contact EK	Contact EK	Large	Large	Standard
Base-P LP 1-0 OO	-	Standard	Standard	Standard	Standard	Standard
Base-P LP 1-0 OO and HR equipment	-	Standard	Standard	Standard	Standard	Standard
Base-P LP 1-1 OO	-	Standard	Standard	Standard	Standard	Standard
Base-P LP 1-1 OO and HR equipment	-	Standard	Standard	Standard	Standard	Standard
Base-P MP 1-0 OO	-	Standard	Standard	Standard	Standard	Standard
Base-P MP 1-0 OO and HR equipment	-	Standard	Standard	Standard	Standard	Standard
Base-P MP 1-1 OO	-	Standard	Standard	Standard	Standard	Standard
Base-P MP 1-1 OO and HR equipment	-	Standard	Standard	Standard	Standard	Standard
Base-T	-	Standard	Standard	Standard	Standard	Standard
Base-T and HR equipment	-	Contact EK	Contact EK	Large	Large	Standard

CRIO HE+ R290 range		142-2-2 PV	175-2-2 PV
DIMENSIONS AND WEIGHTS - Standard unit			
Lenght	[mm]	4015	4015
Width	[mm]	2280	2280
Height (ST - LN)	[mm]	2535	2535
Height (SL)	[mm]	2560	2560
Shipping weight (A BP/ST/AS/EC/** version)	[kg]	2575	2590
Operating weight (A BP/ST/AS/EC/** version)	[kg]	2593	2608

DIMENSIONS - Large unit			
Lenght	[mm]	-	-
Width	[mm]	-	-
Height (ST - LN)	[mm]	-	-
Height (SL)	[mm]	-	-

Unit dimensions with hydronic kit			
Integrata LP 1-0 OO	-	Standard	Standard
Integrata LP 1-0 OO and HR equipment	-	Standard	Standard
Integrata LP 1-1 OO	-	Standard	Standard
Integrata LP 1-1 OO and HR equipment	-	Standard	Standard
Integrata MP 1-0 OO	-	Standard	Standard
Integrata MP 1-0 OO and HR equipment	-	Standard	Standard
Integrata MP 1-1 OO	-	Standard	Standard
Integrata MP 1-1 OO and HR equipment	-	Standard	Standard
Base-P LP 1-0 OO	-	Standard	Standard
Base-P LP 1-0 OO and HR equipment	-	Standard	Standard
Base-P LP 1-1 OO	-	Standard	Standard
Base-P LP 1-1 OO and HR equipment	-	Standard	Standard
Base-P MP 1-0 OO	-	Standard	Standard
Base-P MP 1-0 OO and HR equipment	-	Standard	Standard
Base-P MP 1-1 OO	-	Standard	Standard
Base-P MP 1-1 OO and HR equipment	-	Standard	Standard
Base-T	-	Standard	Standard
Base-T and HR equipment	-	Standard	Standard

CRIO range

CRIO BS

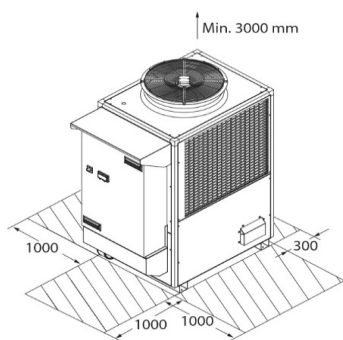

7-1-1 PE ↔ 28-1-1 PE

Cooling capacity
from 7 kW to 28 kW

CRIO HE/HE+

10-1-1 PE ↔ 17-1-1 PE

Cooling capacity HE
from 10 kW to 17 kW
Cooling capacity HE+
from 10 kW to 17 kW

CRIO BS

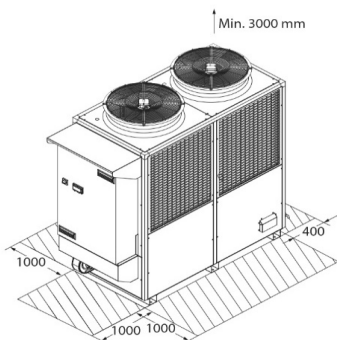

33-1-1 PE ↔ 68-1-1 PE

Cooling capacity
from 33 kW to 68 kW

CRIO HE/HE+

20-1-1 PE ↔ 48-1-1 PE

Cooling capacity HE
from 20 kW to 48 kW
Cooling capacity HE+
from 21 kW to 36 kW

CRIO BS

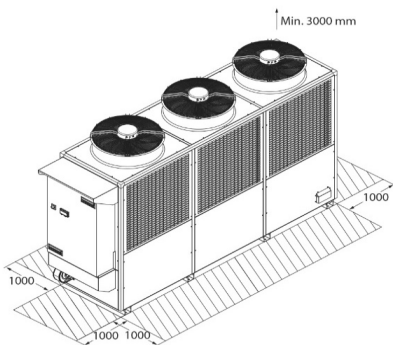

79-2-2 PE ↔ 137-2-2 PE

Cooling capacity
from 79 kW to 137 kW

CRIO HE/HE+

56-1-1 PE ↔ 97-2-2 PE

Cooling capacity HE
from 56 kW to 97 kW
Cooling capacity HE+
from 56 kW to 83 kW

CRIO range

CRIO BS

CRIO HE/HE+

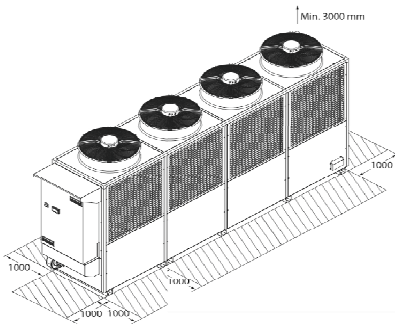

157-2-2 PE ↔ 173-2-2 PE

Cooling capacity
from 157 kW to 173 kW

99-2-2 PE ↔ 116-2-2 PE

Cooling capacity HE
116 kW

Cooling capacity HE+
from 99 kW to 116 kW

CRIO BS

CRIO HE/HE+

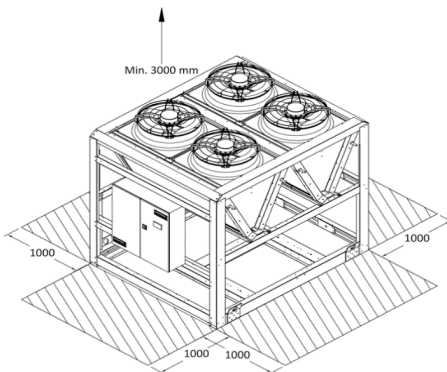

158-2-2 PV ↔ 182-2-2 PV

Cooling capacity
from 158 kW to 182 kW

130-2-2 PE ↔ 142-2-2 PE

Cooling capacity HE
from 130 kW to 142 kW

Cooling capacity HE+
from 130 kW to 142 kW

CRIO BS

CRIO HE/HE+

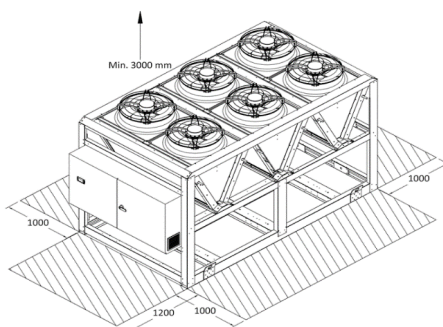

161-2-2 PV ↔ 185-2-2 PV

Cooling capacity HE
from 161 kW to 185 kW

Cooling capacity HE+
from 161 kW to 185 kW

CRIO

Standard equipment and Accessories

General

Optional accessories

Anti-vibration rubber mounts (supplied separately)



Rubber vibration isolation mounting (Kit). The system prevent the transmission of vibrations to the structure where the unit is located.

Anti-vibration seismic spring mounts (supplied separately)



Seismic vibration isolation mounting (Kit). The system prevent the transmission of vibrations to the structure where the unit is located.

Aluminum panels (fan panel not included)

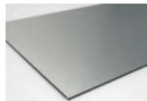

Aluminium-based panels, with the exception of fan(s) bellmouth, allow to reduce the weight of tje unit and ensure higher wethering resistance.

Panels insulated with polyurethane foam sheets



Painted galvanized sheet panels, insulated with polyurethane foam sheets, polyester based, anthracite colour, selfextinguishing non dripping. **Standard for LN version.**

Anti-vibration spring mounts (supplied separately)



Spring vibration isolation mounting (Kit). The system prevent the transmission of vibrations to the structure where the unit is located.

Condensing coil protection panel



Metal protection anti-intrusion grid for condensing coil against accidental impacts. Available for "PE" and "PV" models. The picture on the left refers to "PE" shaped coils.

Metallic filters for condensing coils



Metallic filters specially designed for condensing coils applications on industrial chillers, made of an aluminum sheet frame and microextruded aluminum mesh. These filters ensure very low pressure drops and their design allow to cover large suction surfaces.

Stainless steel panels (AISI 304) - (fan panel not included)

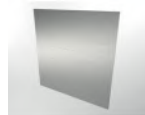

Stainless steel-based (AISI 304) panels, with the exception of fan(s) bellmouth, allow higher rusting resistance.

Sandwich soundproofing galvanized sheet panels



Sandwich soundproofing galvanized sheet panels, painted outside and isolated with high- density rock wool (100 Kg/m³). **Standard for SL version**

Standard equipment and Accessories

Condensing section

Optional accessories

Condensing coil with ElectroFin® treatment



ElectroFin® treatment delivers corrosion durability protection for fins and tubes, increasing efficiency and length of service.

Condensing coil with Thermoguard treatment



The Thermoguard treatment is a polyurethane-based anticorrosive coating with high flexibility that protects the exchangers from the hostile conditions of corrosive environments, ensuring longer life of the unit. The product includes aluminum pigments that improve its thermal conductivity and resistance to UV rays. The purpose of the product is to provide protection and prevention against the chemical and galvanic corrosion of the heat exchangers.

Condensing coil with Blygold® treatment



The Blygold® treatment provides a long-lasting corrosion protection to heat exchangers, without affecting heat transfer and pressure drop. The heat conductive pigmentation in the coating is oriented in such a way that it creates a very high chemical resistance at a low layer thickness.

Condensing coil with AiAX Coatings treatment



The AiAX Coatings treatment protects the exchangers from the hostile conditions of the most aggressive environments. The treatment is specially designed to resist thermal contractions and expansions, UV rays, it is dirt repellent, mechanically resistant and with very limited heat transfer losses. It has practically no effects on air side pressure drop.

Condensing coil with Heresite P413 treatment



The Heresite P413 treatment is a thin film, high performance coating used for protecting heat exchangers. It is the first HVAC-R coil coating to meet the ISO 20340 Standard for severe offshore marine environments. The corrosion resistance of Heresite P413 coatings significantly extends the service life of heat exchangers. In addition to marine and salt air environments, the P413 coatings will withstand exposure to an extensive variety of high and low pH corrosive and chemical fumes and condensate.

Cu/Cu condensing coil



Stainless steel-based (AISI 304) panels, with the exception of fan(s) bellmouth, allow higher rusting resistance.

CRIO

Standard equipment and Accessories

Refrigerant circuit section

Standard accessories

High & Low pressure manometers



Gauges for the control of low and high refrigerant pressures, embedded in glycerine.

Suction and discharge compressor's valves



Intercepting valves on compressor's suction and discharge sides to facilitate maintenance activities.

Pressure switch-HP side



Pressure switch installed on HP side according to EN-378:2016 standard to protect the circuit against high-pressure risk.

Compressor crankcase oil heater



Crankcase oil heater directly installed on the compressor in order to increase compressor reliability and ensure adequate oil temperature.

Electronic expansion valve



Electronic expansion valve for the accurate and timely control of the superheater level, after evaporation and many others operative functions.

Safety valve – HP side



Safety valve(s) installed on HP side according to EN-378:2016 standard to protect the circuit against highpressure risk. The safety valve(s) is (are) standard for some models only, according to EN-378:2016 requirements. See accessories Table for more details. All safety valves are conveyed outside the unit.

Optional accessories

Pressure switch - LP side



Pressure switch installed on LP side to prevent risks related to excessively low evaporating temperatures.

Double Safety valve with changeover valve



Double safety valve with changeover valve installed to ensure easy maintenance. This solution is available both for HP and LP side. All safety valves are conveyed outside the unit.

Safety valve – LP side



Safety valve(s) installed on LP side to protect refrigeration circuit against low pressure risk. All safety valves are conveyed outside the unit.

Gauges



Gauges for the control of oil pressure, embedded in glycerine.

Standard equipment and Accessories

Electrical cabinet section

Standard accessories

Electrical panel installed outside the unit



To ensure higher security level, the cabinet is mounted outside the machine. The propane sensor is equipped with separate power supply.
Standard power supply: 400V/3ph/50hz.
Emergency power supply: 230V/1ph/50hz

Double- barrier



The cable entry plates consist of a robust hard frame made of plastic which ensure the tightness of the electrical panel.

Optional accessories

Phase monitoring sequence relay



Sequence phases relay mounted directly inside the electrical box and with the function of stopping the unit in the case where the phase sequence is not correct.

Min./Max. voltage relay



Min and max power supply relays mounted directly inside the electrical box and with the function of stopping the unit in case the power supply voltage is outside the tolerance range.

Anti-condensation heater with thermostat



System able to ensure, inside the enclosure, temperature value properly above the dew point.

Power factor correction capacitors for compressors



Power factor compressor capacitor to keep the value of the $\cos\phi$ higher than 0,9.

Emergency power electronic expansion valve (Ultracap module)



Ultracap is a emergency power supply device for systems that use electronic expansion valves: this device ensures complete closing of the valves even when there are sudden mains power failures.

Device for measuring the electric energy consumed (Energy meter)



Measuring instrument dedicated to the detection of the main electrical parameters and the consumption of the connected loads. Energy meter records consumption and allows for a complete and detailed analysis.

Compressors' capacity steps – RSH Heads



The innovative RSH technology limits overheating and avoid the compressor to work unbalanced, ensuring optimized operation at partial loads even for long operation periods. One RSH head is standard for HE+ models.

Inverter



Inverter driven compressor allows to increase drastically the efficiency at part loads.
Standard for HEI version.

Control section

Optional accessories

Remote control panel



Remote user terminal can be used to get all the readings and duplicate commands on a second display located at a distance and in more accessible site compared to the microprocessor on board the machine.

Connectivity



CRIO

Standard equipment and Accessories

Water circuit section

Standard accessories

Differential pressure switch



Differential pressure switch with function to control the failure or reduced water flow.

Air vent valve (manual)



Manual air vent valve for discharging air from water circuit.

Electromechanical water flow switch (supplied separately)



Electromechanical flow switch with function to control the failure or reduced water flow.

Increased thermal insulation – 19 mm



Closed-cell thermal insulation with special thickness of 19 mm, which ensures an adequate protection against moisture from condensation. For Integrated version adequate insulation is provided also for the pump.

Optional accessories

Pressure relief valve (4,5 bar setting)



Pressure relief valve for hydraulic circuit. Default setting: 4.5 Bar

Automatic overpressure by-pass valve



Water circuit automatic overpressure by-pass valve.

Sacrificial anode installed inside the unit



Sacrificial anode installed inside the unit prevents the evaporator corrosion by means cathodic protection.

High pressure water pump (increased pump pressure)



Pumping group consisting of high head centrifugal electric pump (peripheral for models 21 and 31), suitable for water circuits with high pressure drops.

Open expansion tank



Open expansion vessel for the containment of pressure variations in the water circuit. The fluid is in direct contact with the atmosphere.

Flanged connections



Flanged couplings for water connections. Available materials: carbon steel and AISI 304L steel (only for nonferrous circuits).

Electronic water flow switch (supplied separately)



Electronic flow switch with function to control the failure or reduced water flow.

Air vent valve (automatic)



Automatic air vent valve for discharging air from water circuit.

Non-ferrous water circuit



Water circuit made entirely from non-ferrous material.

Double water pump (stand-by) - Standard pressure



Pumping group consisting of two centrifugal electric pumps, one in stand-by (peripheral for model 21), with standard pressure drops.

Closed expansion tank with automatic filling valve



Closed expansion vessel for the containment of pressure variations in the water circuit. The fluid is separated from the gas chamber by a diaphragm and the tank is equipped with an automatic filling valve.

Victoulic couplings



Victoulic couplings for water connections, which ensure easy start-up operations.

Standard equipment and Accessories

Safety section

Standard accessories

ATEX certified Gas detector



The unit is equipped with a stand-alone gas detection system. The sensor is ATEX certified and is pre-calibrated at the factory. The standard setting is set at 10% of LFL (Low Flammability Limit).

EC emergency fan



The centrifugal EC fan, managed by the microprocessor, is activated in case of R290 leakage and the ventilation lasts until the dilution of the refrigerant gas is completed. Additional accessories are available to convey the air discharge. Power supply: 230V-1ph- 50Hz

Optional accessories

Double gas detector



The redundancy of the ATEX certified gas detector allows a higher level of security to be achieved.

Calibration kit



The R290 leak detector requires periodic maintenance: the calibration must be carried out according to the indications of the manual. The calibration kit, which allows calibration to be carried out quickly and easily, consists of:

- adapter;
- pressure regulator and pressure gauge;
- service tool

Sound alarm



The sound alarm, installed on the electrical panel, is activated in case of R290 leakage.

Flanged connection for emergency fan air outlet



Flange to convey the air discharge in rectangular section air ducts. The flange is supplied separately.

Emergency stop button



Safety switch for emergency stop installed on the electrical panel.

CRIO

Euroklimat firmly believes that Customer Satisfaction is an indispensable factor for success. A priority objective to achieve this result is the constant improvement of our products, services and the relative production processes. For this reason, we work every day to create reliable products that can help our customers in their business. To achieve this goal, for every single unit we produce there is a lot of work. Therefore, we are pleased to tell you how Euroklimat's CRIO Medium Temperature Chillers are made.

1 Products design and development

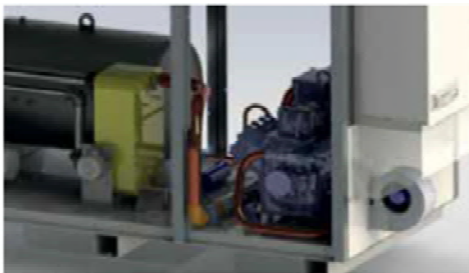

Starting from market's needs we draft a concept which is then transformed into a product. The design involves many people of the company and results in the production of all the necessary documentation such as installation and operating manual, P&ID diagrams, wiring diagrams, 3D drawings and much more.

2 Supply chain

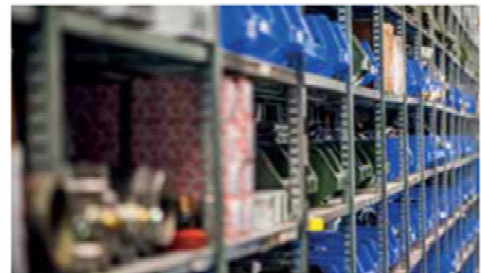

The materials procurement process is the result of a constant partnership with all our suppliers and a careful management of the timing. To do this we use modern manufacturing techniques such as MRP (Material Requirements Planning), trend analysis, which are some of the tools that feed the issuance of orders. Euroklimat's supply chain ends with the reception of the materials and their quality check.

3 Mechanical assembly

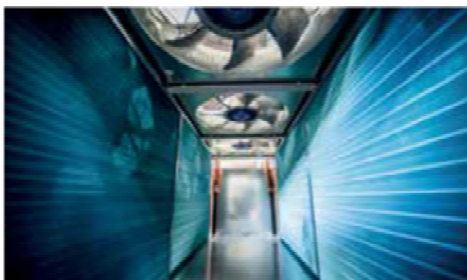

The production of the units starts at the mechanical assembly station. Here the structures are assembled and the main components such as compressors and heat exchangers are positioned and fixed.

4 Water circuit

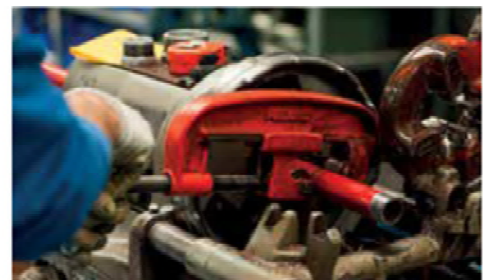

Then the production continues at the water circuit assembly station where all the components of this circuit are mounted.

How it is made

The whole production cycle is subjected to Euroklimat's Quality Management System, that complies with the international standard UNI EN ISO 9001:2015, ensuring quality and long-term reliability.

5 Refrigerant circuit

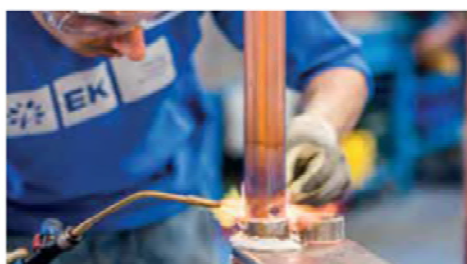

The next step is at refrigerant circuit assembly station. Here the pipes of the circuit are assembled and brazed welded, which will connect the various elements of the unit, such as compressor(s), condenser(s), evaporator(s), etc. The refrigerant circuit is specifically designed in order to minimize load losses and to avoid capacity reduction. The circuit is entirely made of copper tube brazed with silver alloy and it is isolated on the suction part, in order to avoid condensation.

6 Electrical wiring

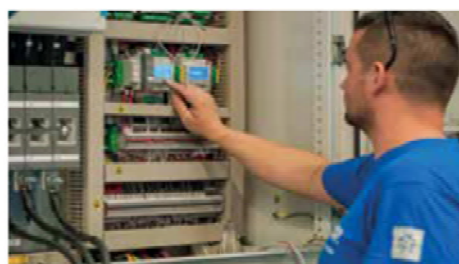

Once completed the refrigeration and water circuit, we perform the electrical wiring and the connection between electric board and compressor, fan, pump, etc. Each unit is equipped with electric panel, built, wired and fully tested at the factory. Wiring numeration and optimized layout facilitate troubleshooting. The installed components are identified by nameplates to better identify the application and the type of action.

7 Running test area

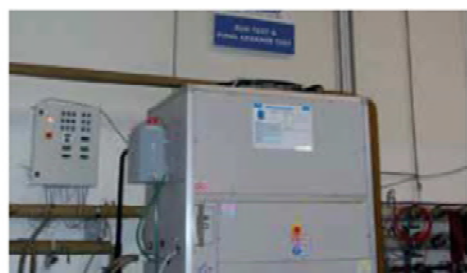

The production cycle draws to a close at the running test station. Here all models are individually tested in order to check correct operation, refrigerant charge and settings of microprocessor. Once all the checks and inspections are completed and successfully passed, the units are disconnected from the testing station and moved to the last station: the shipping area.

8 Final inspection and packaging area



The last phase of the production cycle concerns the finishing of the units and the packaging for shipping. Here all the units are subjected to a final check and prepared for the shipping. If a special packaging has not been requested the standard one is realized with heat-shrinkable plastic film that cover the whole unit and protect it from dust, water and other atmospheric agents. Polystyrol corners are also foreseen in order to protect the unit from potential damages caused during transports. The units are then ready for transportation and final installation.

WebService²

What do I receive with my order?

When you order an Euroklimat product, after the order confirmation, you get your user ID and password to access to WebService².

With the advent of information technology, there are several possibilities for communication and transmission of information in real-time.

Euroklimat wanted to exploit these instruments creating a website, which provides an important support to all customers: WebService².



WebService² - web portal 24/7

The simple and intuitive interface of the site allows you to “browse” quickly and easily reach the information you need. Planned and designed for the specific competences, “webservice” is a web portal that enables customers or support centres to access the detailed documentation for each single machine:

- » order confirmation, waybill and invoice
- » declaration of conformity
- » instructions manual
- » electric diagram
- » construction drawing
- » complete list of spare parts
- » ... and much much more.



Websevice²



The information is consequently always available and up-to-date, also when you are physically at the site of installation.

Thanks to the new features of WebService2, it is now possible to check in real time the availability of spare parts for each serial number, simply by accessing the service with your own web credentials.

The “mission” of Euroklimat is always to improve the service offered to customers.





Our plants and quality management

Over 50 years of business

Since we set up business in 1963, the company's head offices have always been in Italy, near Milan. Today, our aim is to be a market leader in chillers with natural refrigerant (propane): by doing this, we are helping the industry to become more efficient, preserving natural resources and protecting the environment.

Organization in Italy

At our Italian plant spread over an area of 6,000 square metres, with a work force of 60 people, Euroklimat designs and produces refrigeration units, heat pumps and precision air conditioners that can be used both in industrial processes and traditional comfort applications.

Infinite quality

Euroklimat firmly believes that Customer Satisfaction is an indispensable factor for success. A priority objective to achieve this result is the constant improvement of our products, services and the relative production processes.

This objective means involving all of the company's resources with planned, systematic activities for Quality; for this reason, our system complies with the international standard UNI EN ISO 9001:2015.

Organization in China

Our plant covers a surface of approximately 100,000 square metres, with over 1,000 people and includes a large test chamber and a sophisticated R&D laboratory, in addition to real production departments, where the performance of the units is measured before being placed on the market.



COMPANY
WITH QUALITY SYSTEM
CERTIFIED BY DNV GL
= ISO 9001 =



Stabilimento Italia • Sizzano



Stabilimento Cina • Huangjiang, Dongguan, Guangdong



EUROKLIMAT SpA

Factory Italy

Via Liguria, 8
27010 Siziano (PV) Italy

T: +39 038 2610282
E: info@euroklimat.it

www.euroklimat.it

Euroklimat Co., Ltd

Factory China

Euroklimat Industrial Park
Huangjiang, Dongguan, Guangdong, China

T: +86 0769 8366 0888 ext. 8260
E: info@euroklimat.it

www.euroklimat.com.cn

EUROKLIMAT FZCO

Office Dubai

High Bay Office 24, Dubai Silicon Oasis, UAE
PO Box 28178, Dubai, UAE

T: +971 4 3423152
E: info@ek-me.com

www.euroklimatme.com

green ❄️
cooling initiative